

2016

ATHLON
OPTICS



PRODUCT CATALOG

BINOCULARS | RIFLESCOPES | SPOTTING SCOPES | RED DOTS



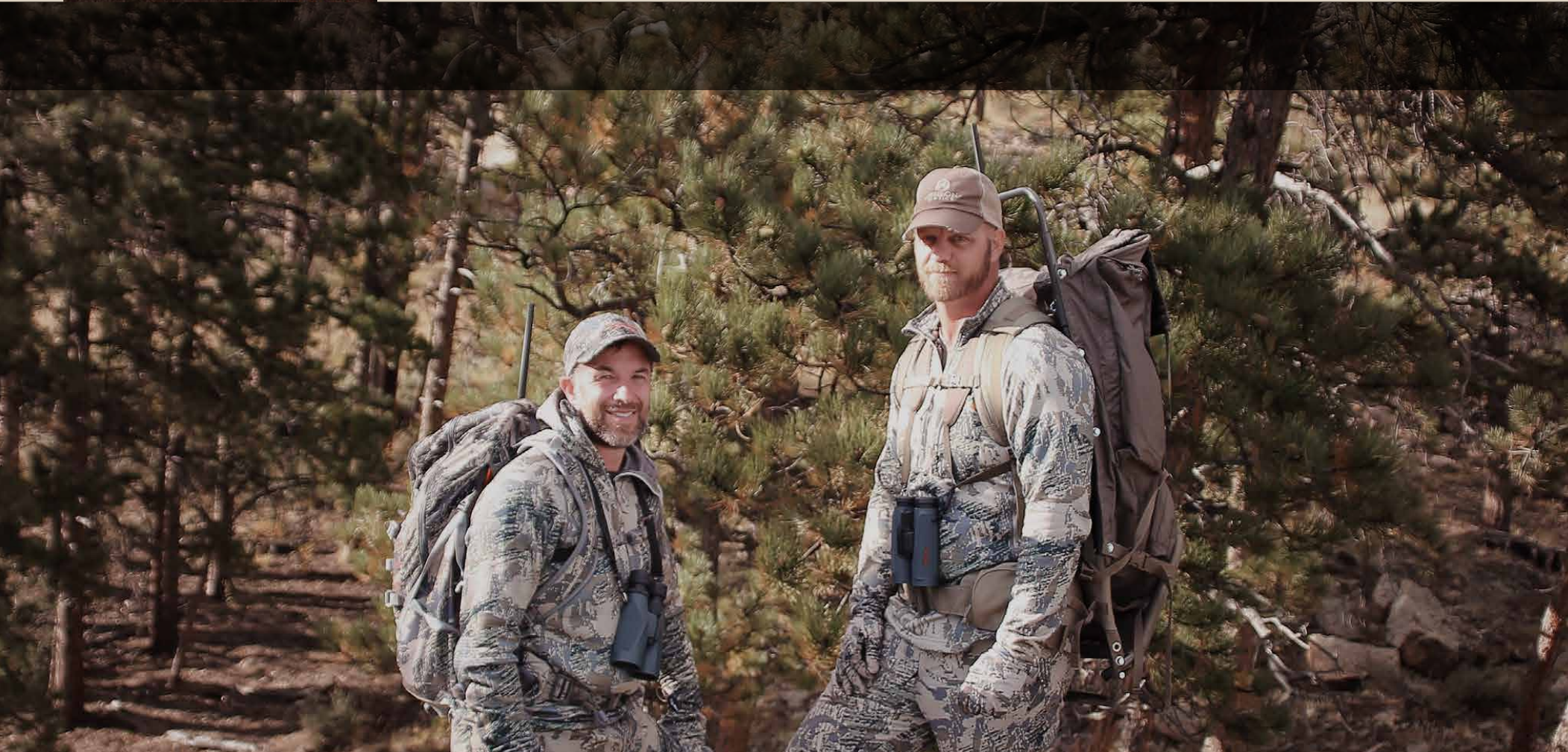

CONTENT

BINOCULARS

- 4-5 **CRONUS**
10x42, 8.5x42
- 6-7 **ARES**
10x42, 8x42, 10x36, 8x36
- 8 **MIDAS**
12x50, 10x50, 10x42, 8x42
- 9 **ARGOS**
12x50, 10x50, 10x42, 8x42, 10x34, 8x34
- 10 **TALOS**
12x50, 10x50, 10x42, 8x42, 10x32, 8x32
- 11 **NEOS**
12x50, 10x50, 10x42, 8x42, 10x32, 8x32

RIFLESCOPES

- 12-13 **CRONUS**
1-6x24, 4.5-29x56
- 14-15 **MIDAS^{BTR}**
1-6x24, 2.5-15x50, 4.5-27x50
- 16-17 **ARGOS^{BTR}**
1-4x24, 6-24x50, 8-34x56
- 18 **ARGOS**
2-10x40, 3-15x40, 4-20x50, 6-30x56
- 20 **TALOS^{BTR}**
1-4x24, 4-14x44

- 21 **TALOS**
3-12x40, 4-16x40, 6-24x50
- 22-23 **NEOS**
3-9x40, 4-12x40, 6-18x44

SPOTTING SCOPES

- 24-25 **CRONUS**
20-60x86 ED, 12-36x50 ED
- 26-27 **ARES**
20-60x85 ED, 15-45x65 ED, 7.5-22.5x50 ED

TECHNICAL INFORMATION

- 28-31 **CRONUS RIFLESCOPES**
- 32-33 **MIDAS^{BTR} RIFLESCOPES**
- 34-37 **ARGOS^{BTR} RIFLESCOPES**
- 38-39 **ARGOS RIFLESCOPES**
- 40-41 **TALOS^{BTR} RIFLE SCOPES**
- 42-43 **TALOS RIFLE SCOPES**
- 44-45 **NEOS RIFLESCOPES**

KEY PRODUCT FEATURES



Apochromatic lens system gives you the result of images which have greater contrast, sharpness and color definition.



Argon purging gives you better waterproofing and thermal stability



ED glass gives you an image with little or no chromatic fringe for a clearer and sharper image



HD glass gives you the utmost contrast, color reproduction, and the sharpest image.



E2ES System is a field flattening system that produces sharper, clearer images all the way from one lens edge to another



XPL Coating gives you an extra protection on the exterior lenses from dirt, oil and scratches



Multicoated optics effectively reduce reflected light and increase the transmission of light giving you a brighter image than normal single coated lenses



ESP Dielectric Coating is a multi layer prism coating that reflects over 99% of the light to your eyes bringing you a clear, bright image that displays accurate color reproduction.



Bak-4 glass prisms reflect more light to your eyes thus will give you brighter and sharper image.



Waterproof to protect in the harshest weather conditions or if accidentally submerged underwater.



Advanced Fully Multi-Coated lenses deliver the highest level of light transmission for maximum brightness and true color across the entire light spectrum.



Phase corrected prisms produce images that have better contrast, a higher resolution and excellent color reproduction.



Fully Multi-Coated lenses bring you better light transmission to bring optimum brightness and true color across the entire light spectrum.

YOUR PRIZE IN OPTICS

ATHLON is a proud US sports optics product company devoted to designing and delivering superior quality optics products and outdoor accessories at a competitive price to our consumers via our distribution and retail channels. Athlon has strong engineering design capability, strategic alliances with quality manufacturers and a streamlined fully integrated supply chain. These advantages enable us to bring the latest cutting edge technologies and cut out the extra layers of traditional supply chain. With these advantages we are able to deliver goods

and products to individual consumers' hands with great cost savings. Our obsession with product quality and superior customer service for hunters, recreational shooters, and outdoor enthusiasts drives our business. The business model on which we founded ATHLON allows us to deliver high quality optics at extremely competitive prices. Our goal from day one is to pass those savings to you, the outdoor enthusiast.

**WE ARE CONFIDENT
THAT YOU WILL BE ABLE TO
MAKE THE SHOT
YOU NEED REGARDLESS
OF WHEN YOU BOUGHT
OUR SCOPE**

ATHLON LIFETIME WARRANTY

Your Athlon product is not only warranted to be free of defects in materials and workmanship for the lifetime of the product. Athlon will also repair or replace, at no charge to you, your product if you should damage it through normal use. No receipt needed, no registration required. This is a commitment that Athlon Optics will be the best product you can buy for your money. This warranty does not cover damages caused by deliberate damage, misuse, theft or maintenance provided by someone other than the Athlon Authorized Service Department.



CRONUS



“COMBINED COMMITMENT TO BRIGHTNESS, CLARITY AND RESOLUTION”

Just like its namesake, Cronus the King of all the Mythological Greek Titans, this is the top of the Athlon Optics products. Athlon brings to you in the Cronus family, products inspired by a combined commitment to brightness, clarity and resolution.

Designed for serious glassing, with exceptional edge to edge clarity, sharp detail enhancement, ultra-clear brightness and true color representation. Whether you are on your annual hunt for whitetails on the family farm in Ala-

Key Features:



Argon purging gives you better waterproofing and thermal stability



ED glass gives you an image with little or no chromatic fringe for a clearer and sharper image



E2ES System is a field flattening system that produces sharper, clearer images all the way from one lens edge to another



XPL Coating gives you an extra protection on the exterior lenses from dirt, oil and scratches



ESP Dielectric Coating is a multi layer prism coating that reflects over 99% of the light to your eyes bringing you a clear, bright image that displays accurate color reproduction.



Bak-4 glass prisms reflect more light to your eyes thus will give you brighter and sharper image.



Waterproof to protect the binocular in the harshest weather conditions or if accidentally submerged underwater.



Advanced Fully Multi-Coated lenses deliver the highest level of light transmission for maximum brightness and true color across the entire light spectrum.



Phase corrected prisms produce images that have better contrast, a higher resolution and excellent color reproduction.

OTHER FEATURES: Magnesium chassis, Locking diopter, Long eye relief, Close focus, Twist up eyecups

42mm



...bama or filling your tag on an once in a lifetime Montana Big Horn, don't leave anything to chance. We designed these binoculars with our revolutionary E2ES lens system that gives you a flat field of view. We included ED Glass that results in clearer and sharper image to your

42mm



eyes. Our state of the art ESP (Enhance Spectral Prism) dielectric coating that reflects 99% of the light through the prism assembly. We use a Magnesium chassis to reduce weight while keeping the chassis rugged to withstand the scrapes and bumps of constant use.

CRONUS SPECIFICATION

	OBJ. LENS DIA.	EYE RELIEF	FIELD OF VIEW ANGULAR	FOV @1000 YARDS	CLOSE FOCUS	INTERPUPILLARY DIST.	WEIGHT	HEIGHT X WIDTH
10x42	42 mm	19.3 mm	6.5 °	338 ft	6.6 ft	56-73 mm	33 oz	6.3x5.1"
8.5x42	42 mm	19.3 mm	7.6 °	399 ft	6.6 ft	56-73 mm	33 oz	6.3x5.1"



ARES



Ares lightweight open-bridge design is an example of the new innovative thinking that went into the unique design. Put in a few words, Ares optics are first-class.

They have ED glass lenses with Advance multi-coated and feature BaK4 prisms with the new ESP Dielectric Coating and Phase Coating. They bring super-premium clarity and brightness within the reach of most avid enthusiasts. Their tough Magnesium chassis is fog proof and waterproof and filled with Argon to give you better internal fog proofing and thermal stability. They are covered with a durable rubber armor.

Bottom line? Just like Ares the Greek god of war, they will stand up to a punishment. They're the perfect combination of lightweight construction, optical quality and rugged durability.

Key Features:



Argon purging gives you better waterproofing and thermal stability



ED glass gives you an image with little or no chromatic fringe for a clearer and sharper image



XPL Coating gives you an extra protection on the exterior lenses from dirt, oil and scratches



ESP Dielectric Coating is a multi layer prism coating that reflects over 99% of the light to your eyes bringing you a clear, bright image that displays accurate color reproduction.



Bak-4 glass prisms reflect more light to your eyes thus will give you brighter and sharper image.



Waterproof to protect the binocular in the harshest weather conditions or if accidentally submerged underwater.



Advanced Fully Multi-Coated lenses deliver the highest level of light transmission for maximum brightness and true color across the entire light spectrum.



Phase corrected prisms produce images that have better contrast, a higher resolution and excellent color reproduction.

OTHER FEATURES: Magnesium chassis, Long eye relief, Close focus, Twist up eyecups

42mm



36mm



ARES SPECIFICATION

	OBJ. LENS DIA.	EYE RELIEF	FIELD OF VIEW ANGULAR	FOV @1000 Yards	CLOSE FOCUS	INTERPUPILLARY DIST	WEIGHT	HEIGHT X WIDTH
10x42	42 mm	14.7 mm	6.5 °	341 ft	8.2 ft	56-73 mm	29.8 oz	6.7x5.2"
8x42	42 mm	16.5 mm	6.5 °	426 ft	6.5 ft	56-73 mm	29.8 oz	6.7x5.2"
10x36	36 mm	13.9 mm	6.17 °	351 ft	8.2 ft	56-74 mm	24.9 oz	6.1x4.9"
8x36	36 mm	14.9 mm	7.17 °	405 ft	6.5 ft	56-74 mm	24.9 oz	6.1x4.9"

MIDAS



Key Features:



Argon purging gives you better waterproofing and thermal stability



ED glass gives you an image with little or no chromatic fringe for a clearer and sharper image



Phase corrected prisms produce images that have better contrast, a higher resolution and excellent color reproduction.



XPL Coating gives you an extra protection on the exterior lenses from dirt, oil and scratches

OTHER FEATURES: Magnesium chassis, ESP Dielectric Coating, Bak-4 glass prisms, Advanced Fully Multi-Coated lenses, Long eye relief, Close focus, Twist up eyecups, Waterproof

Midas was known to have a golden touch. He must have laid his hands on these binoculars since they set the gold standard for this class of binoculars. The rugged benchmark for all-weather brightness and clarity, Midas roof-prism binoculars are light and slim thanks to a magnesium chassis. With their ED Glass lenses, Advanced Fully multi-coated optics, high-quality Bak-4 prisms with our ESP Dielectric coating plus phase coating, the Midas binos gather maximum light and produce brilliant color fidelity.



50mm



42mm

ARGOS



Key Features:



Argon purging gives you better waterproofing and thermal stability



ESP Dielectric Coating is a multi layer prism coating that reflects over 99% of the light to your eyes bringing you a clear, bright image that displays accurate color reproduction.



Phase corrected prisms produce images that have better contrast, a higher resolution and excellent color reproduction.



XPL Coating gives you an extra protection on the exterior lenses from dirt, oil and scratches

OTHER FEATURES: Bak-4 glass prisms, Advanced Fully Multi-Coated lenses, Long eye relief, Close focus, Twist up eyecups, Waterproof

The Argos has an open-bridge style some hunters prefer for its secure ergonomic one-handed grip and comfortable in any weather condition. They come with superior quality and bright lenses that are Advanced fully multi-coated for sharp contrast, true color and excellent light gathering. They also have Bak-4 prism glass that have our new ESP Dielectric coating and phase correction for color fidelity and sharpness. They also have an Argon purged waterproof, non-fogging polymer composite chassis that takes weight off your neck but stands up to the demands of hunting.



50mm



42mm



34mm



ARGOS SPECIFICATION

OBJ. LENS DIA.	EYE RELIEF	FIELD OF VIEW ANGULAR	FOV @1000 YARDS	CLOSE FOCUS	INTERPILLARY DIST.	WEIGHT	HEIGHT X WIDTH	
50 mm	16 mm	5.4 °	257 ft	13 ft	56-76 mm	29.5 oz	6.8x5.6"	12x50
50 mm	17 mm	6.5 °	304 ft	13 ft	56-76 mm	29.5 oz	6.8x5.6"	10x50
42 mm	16.1 mm	5.4 °	319 ft	13 ft	56-76 mm	24.6 oz	5.7x5.3"	10x42
42 mm	17.3 mm	6.5 °	371 ft	13 ft	56-76 mm	24.6 oz	5.7x5.3"	8x42
34 mm	16 mm	5.4 °	314 ft	13 ft	56-76 mm	16.3 oz	5.1x4.9"	10x34
34 mm	17.4 mm	6.5 °	371 ft	13 ft	56-76 mm	16.3 oz	5.1x4.9"	8x34

TALOS

Key Features:



Bak-4 glass prisms reflect more light to your eyes thus will give you brighter and sharper image.



Waterproof to protect the binocular in the harshest weather conditions or if accidentally submerged under-water.



Phase corrected prisms produce images that have better contrast, a higher resolution and excellent color reproduction.



Advanced Fully Multi-Coated lenses deliver the highest level of light transmission for maximum brightness and true color across the entire light spectrum.

OTHER FEATURES: Long eye relief, Close focus, Twist up eyecups, Nitrogen purged



Whether you're hunting, hiking, fishing or adding species to your life list. The Talos binoculars are built tough, with a rubber-armor housing that's O-ring sealed and nitrogen purged for 100% waterproof/fog-proof dependability. They stretch available light with advanced fully multi-coated optics and premium Bak-4 prisms with phase coating deliver outstanding color fidelity and sharpness. A lightweight composite chassis and streamlined, roof-prism design make them comfortable to carry.



50mm

42mm

32mm

TALOS SPECIFICATION

OBJ. LENS DIA.	EYE RELIEF	FIELD OF VIEW ANGULAR	FOV @1000 YARDS	CLOSE FOCUS	INTERPUPILLARY DIST	WEIGHT	HEIGHT X WIDTH	
50 mm	18.2 mm	5.4°	242 ft	11.48 ft	56-73 mm	29.8 oz	6.7x5.2"	12x50
50 mm	19.5 mm	6.5°	284 ft	9.84 ft	56-73 mm	29.8 oz	6.7x5.2"	10x50
42 mm	15.2 mm	5.4°	341 ft	8.2 ft	56-73 mm	25.5 oz	5.8x4.9"	10x42
42 mm	17.2 mm	6.5°	394 ft	6.56 ft	56-73 mm	25.5 oz	5.8x4.9"	8x42
32 mm	14.8 mm	5.4°	341 ft	9.84 ft	56-73 mm	19.3 oz	4.9x4.3"	10x32
32 mm	14.7 mm	6.5°	427 ft	8.2 ft	56-73 mm	19.3 oz	4.9x4.3"	8x32

NEOS

Key Features:



Bak-4 glass prisms reflect more light to your eyes thus will give you brighter and sharper image.



Waterproof to protect the binocular in the harshest weather conditions or if accidentally submerged under-water.



Multicoated optics effectively reduce reflected light and increase the transmission of light giving you a brighter image than normal single coated lenses

OTHER FEATURES: Long eye relief, Close focus, Twist up eyecups, Nitrogen purged



We build optics to withstand the elements, no matter what class of binos they are in. If you spend any time outdoors you will be near water, and your equipment will spend some time in it. The Neos series binoculars are built tough, with a composite chassis that's O-ring sealed and nitrogen purged for 100% waterproof/fog-proof so if you simply run into foul weather along the way or should you take spill in a mountain stream, or for that matter take a spill overboard, your Neos binos are ready for it. Rubber armoring gives you a grip in slippery situations.



50mm

42mm

32mm

NEOS SPECIFICATION

OBJ. LENS DIA.	EYE RELIEF	FIELD OF VIEW ANGULAR	FOV @1000 YARDS	CLOSE FOCUS	INTERPUPILLARY DIST	WEIGHT	HEIGHT X WIDTH	
50 mm	14 mm	5.4°	294 ft	23 ft	56-72 mm	33.5 oz	7.9x6.9"	12x50
50 mm	19 mm	6.5°	342 ft	16.4 ft	56-72 mm	33.5 oz	7.9x6.9"	10x50
42 mm	14.1 mm	5.4°	309 ft	13.1 ft	56-72 mm	25.5 oz	5.9x4.9"	10x42
42 mm	17 mm	6.5°	367 ft	13.1 ft	56-72 mm	25.5 oz	5.9x4.9"	8x42
32 mm	14.8 mm	5.4°	341 ft	9.84 ft	56-73 mm	19.3 oz	4.9x4.3"	10x32
32 mm	13.6 mm	6.5°	393 ft	16.4 ft	56-72 mm	19.3 oz	4.9x4.3"	8x32





CRONUS RIFLESCOPE SPECIFICATION

POWER X OBJECTIVE LENS	TURRET STYLE	TUBE SIZE	AVAILABLE RETICLES	EYE RELIEF	FOV @100 YARDS	WEIGHT	LENGTH
1-6x24 FFP	CAPPED	30mm	ATSR16 FFP IR MOA	3.9"	95-16 ft	19 oz	10.4"
	EXPOSED		ATSR16 FFP IR MIL				
4.5-29x56 FFP	EXPOSED	34mm	APLR FFP IR MOA	3.6-3.8"	46.2-9.9 ft	35.8 oz	14.4"
			APLR FFP IR MIL				

CRONUS



When compromise is not an option you need to make sure you have the best. That is sufficient reason to own one of the best scopes you can get: The Cronus by Athlon. It is equipped with our advanced multi-coating so you'll have the brightest, clearest image possible in any situation. The innovative new XPL coating protects you lenses from oil, dirt and smudges. The ultra-strong one-piece tube is hammer-forged from an aircraft aluminum alloy for more strength than standard aluminum, multi-piece scope tubes. The 6x magnification ratio eliminates the needs for multiple scopes for different game or types of hunting.

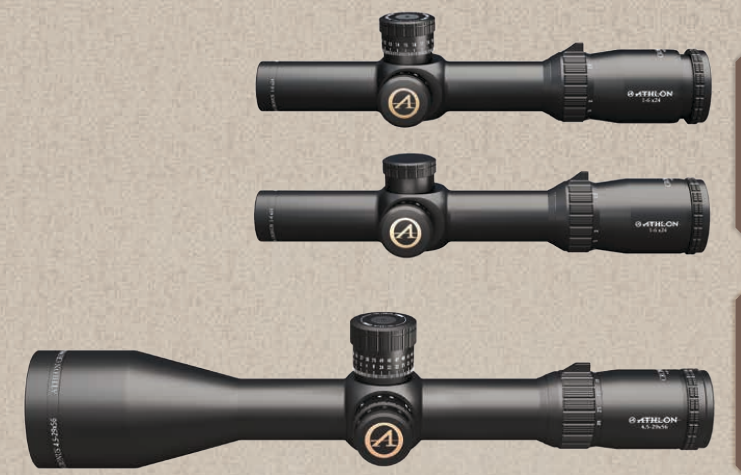

Key Features:

-  **HD Glass** gives you the utmost contrast, color reproduction, and the sharpest image.
-  **Advanced Fully Multi-Coated lenses** deliver the highest level of light transmission for maximum brightness and true color across the entire light spectrum.
-  **XPL Coating** gives you an extra protection on the exterior lenses from dirt, oil and scratches
-  **Argon purging** gives you better waterproofing and thermal stability
-  **Waterproof** to protect the scope in the harshest weather conditions or if accidentally submerged underwater.

First Focal Plane Reticle stays valid at all power settings allowing you to fully utilize the specially designed reticle that shrinks or grows along with your target as you zoom in or out. The reticle offers quick target engagement at low power while offering precise holdover positions with finer details at high power.

High Precision Erector System processed by high precision CNC machine with +/- 0.0001mm tolerance level to provide you the most accurate power settings and smoothest magnification change

Precision Zero Stop System allows you to lock down your zero position and dial back to it with a sharp and precise stop right at your zero location even you are blind folded

OTHER FEATURES: Side Parallax Adjustment, 6061 - T6 - 30/34mm Tubes, Illuminated Glass Reticles, Capped/Exposed Turrets

— FFP reticles

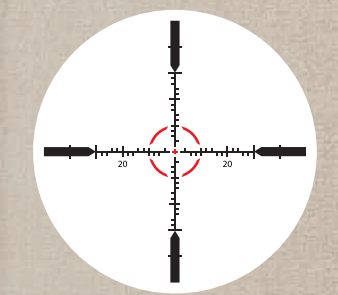

ATSR16 FFP IR-MOA

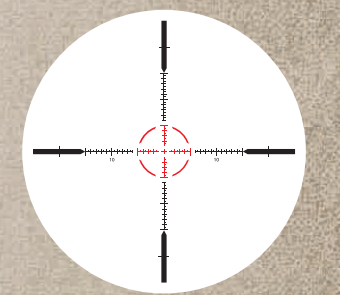

ATSR16 FFP IR-MIL

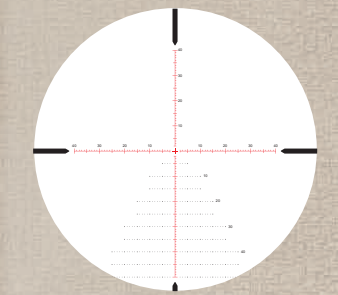

APLR FFP IR-MOA

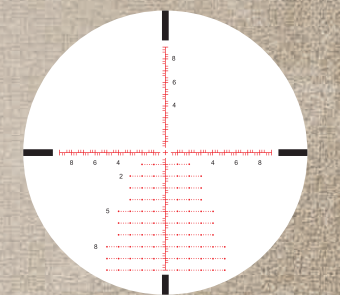

APLR FFP IR-MIL

MIDAS^{BTR} [TACTICAL]



Whether you are shooting prairie dogs at 700+ yards or you are shooting 3 gun that replicates life and death scenarios you want a rifle scope that is accurate, tough, durable and extremely versatile. You need a scope with the Midas touch, it makes every shot gold. The Athlon Midas BTR is ready for anything. It is also equipped with our advanced fully multi-coating so you'll have the brightest, clearest long-distance image possible, in any situation. The innovative new XPL coating protects you lenses from oil, dirt and smudges. The 6x magnification ratio eliminates the needs for multiple scopes for different game or types of hunting.



1-6x24



2.5-15x50



4.5-27x50

Key Features:



HD Glass gives you the utmost contrast, color reproduction, and the sharpest image.



Advanced Fully Multi-Coated lenses deliver the highest level of light transmission for maximum brightness and true color across the entire light spectrum.



XPL Coating gives you an extra protection on the exterior lenses from dirt, oil and scratches



Argon purging gives you better waterproofing and thermal stability



Waterproof to protect the scope in the harshest weather conditions or if accidentally submerged underwater.

High Precision Erector System processed by high precision CNC machine with +/- 0.0001mm tolerance level to provide you the most accurate power settings and smoothest magnification change.

The **6061T6 Aircraft Grade Aluminum Tube** that has exceptional strength and superior mechanical integrity will protect these world class optics no matter what punishment you throw at it.

OTHER FEATURES: Side Parallax Adjustment, Illuminated Glass Reticles, Capped/Exposed Turrets

— SFP reticles

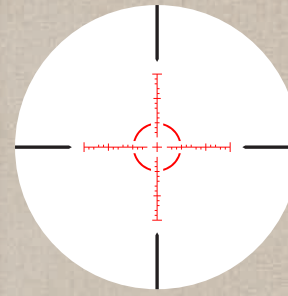

ATSR16 SFP IR MOA

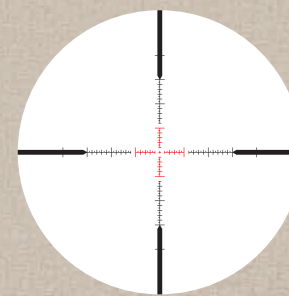

ATSR16 SFP IR MIL

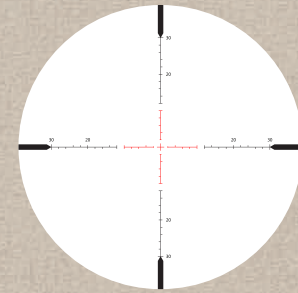

AHMR SFP IR MOA

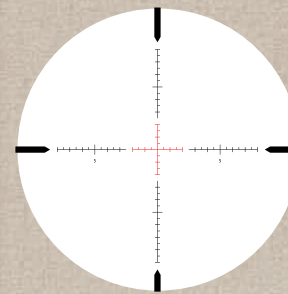

APMR1 SFP IR MIL

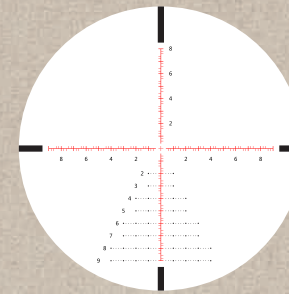

APLR1 SFP IR MOA

MIDAS^{BTR} SPECIFICATIONS

POWER X OBJECTIVE LENS	TURRET STYLE	TUBE SIZE	AVAILABLE RETICLES	EYE RELIEF	FOV@100 YARDS	WEIGHT	LENGTH
1-6X24 SFP	CAPPED	30mm	ATSR16 IR MOA	3.8"	108-17.6 ft	18.1 oz	10.6"
			ATSR16 IR MIL				
2.5-15X50 SFP	EXPOSED	30mm	AHMR SFP IR MOA	3.9"	41.8-6.8 ft	21.4 oz	13.8"
			APMR1 SFP IR MIL				
4.5-27X50 SFP	EXPOSED	30mm	AHMR SFP IR MOA	3.9"	22.7-3.6 ft	21.4 oz	13.8"
			APMR1 SFP IR MIL				
			APLR1 SFP IR MIL				





ARGOS^{BTR} RIFLESCOPE SPECIFICATIONS

POWER X OBJECTIVE LENS	TURRET STYLE	TUBE SIZE	AVAILABLE RETICLES	EYE RELIEF	FOV@100 YARDS	WEIGHT	LENGTH
1-4x24 FFP	EXPOSED	30mm	AHSR 14 FFP IR MOA	3.5"	112-27 ft	20.5 oz	9.8"
			AHSR 14 FFP IR MIL				
6-24x50 FFP	EXPOSED	30mm	ATMR FFP IR MOA	3.3"	16.7-4.5 ft	29.6 oz	14.1"
			APMR FFP IR MIL				
8-34x56 FFP	EXPOSED	30mm	ATMR FFP IR MOA	3.3"	12.5-3 ft	32.2 oz	15.5"
			APMR FFP IR MIL				

ARGOS^{BTR} [TACTICAL]



For those of you that are just getting started in the PRS or are looking to start, take a close look at the Argos BTR family of scopes. These scopes have features normally only found on high-end scopes. It has a 4x magnification that makes it versatile in multiple shooting disciplines. It has our Advanced Fully-Multi Coated Optics that delivers a crystal clear bright image in in dark environments. The Argos BTR also has our exclusive XPL coating that protects your lenses from dirt, grease and harsh weather conditions. The 6061T6 aircraft grade aluminum tube will protect these world class optics no matter what punishment you throw at it.

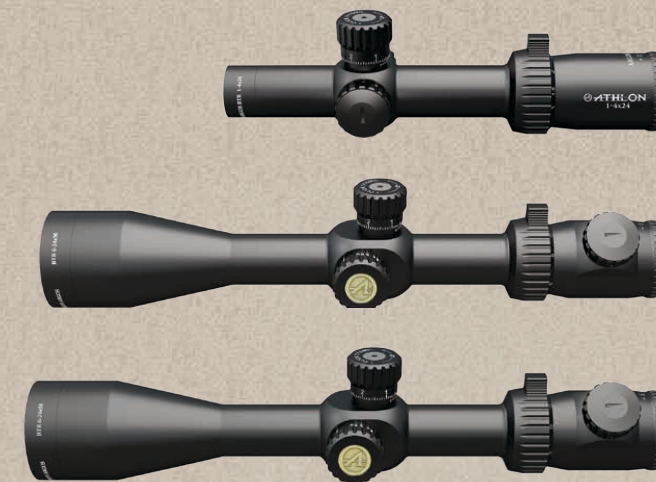

Key Features:



Advanced Fully Multi-Coated lenses deliver the highest level of light transmission for maximum brightness and true color across the entire light spectrum.



XPL Coating gives you an extra protection on the exterior lenses from dirt, oil and scratches



Argon purging gives you better waterproofing and thermal stability



Waterproof to protect the scope in the harshest weather conditions or if accidentally submerged underwater.

First Focal Plane Reticle stays valid at all power settings allowing you to fully utilize the specially designed reticle that shrinks or grows along with your target as you zoom in or out. The reticle offers quick target engagement at low power while offering precise holdover positions with finer details.

The 6061T6 Aircraft Grade Aluminum Tube that has exceptional strength and superior mechanical integrity will protect these world class optics no matter what punishment you throw at it.

OTHER FEATURES:

Side Parallax Adjustment, Illuminated Glass Reticles, Exposed Turrets

— FFP reticles

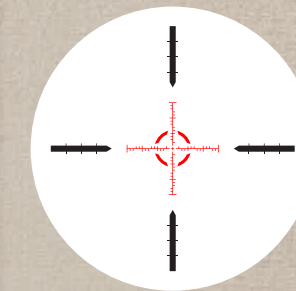

AHSR14 FFP IR-MOA



AHSR14 FFP IR-MIL

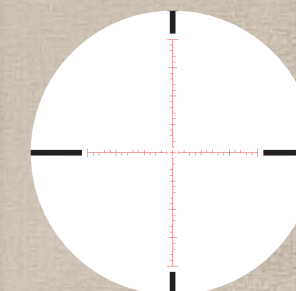

ATMR FFP IR-MOA

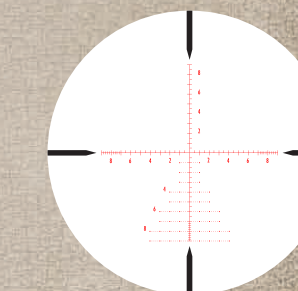

APMR FFP IR-MIL

ARGOS



The Argos family of scopes is one of Athlon Optic's most advanced hunting riflescope lines to date. These scopes have features normally only found on high-end scopes. It has a 5x magnification that makes it versatile in multiple shooting disciplines from up close targets to long range distances. It has our Fully-Multi Coated Optics that delivers a crystal clear bright image in in dark environments. The Argos family also has our exclusive XPL coating that protects your lenses from dirt, grease and harsh weather conditions.

Key Features:



Fully Multi-Coated lenses bring you better light transmission to bring optimum brightness and true color across the entire light spectrum.



XPL Coating gives you an extra protection on the exterior lenses from dirt, oil and scratches



Argon purging gives you better waterproofing and thermal stability



Waterproof to protect the scope in the harshest weather conditions or if accidentally submerged underwater.

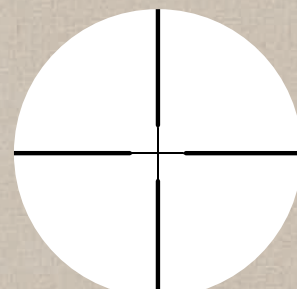

CENTER-X

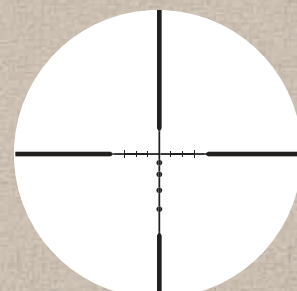

BDC 600

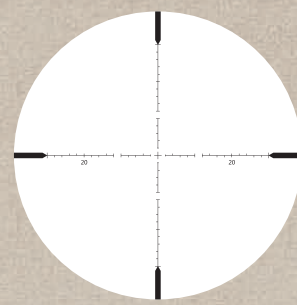

AHMR1 SFP MOA

2-10x40

Second Focal Plane reticle is located at the second plane which stays in between erector tube and ocular lens. The size or the appearance of a second focal plane reticle does not change when you try to zoom in or zoom out.

3-15x40

The 6063 Aircraft Grade Aluminum provides extra strength and durability to handle the toughest terrain and offers lifetime of use.

4-20x50

OTHER FEATURES:

Side Parallax Adjustment, Capped Turrets

6-30x56

— SFP reticles



ARGOS RIFLESCOPE SPECIFICATIONS

POWER X OBJECTIVE LENS	TURRET STYLE	TUBE SIZE	AVAILABLE RETICLES	EYE RELIEF	FOV@100 YARDS	WEIGHT	LENGTH
2-10x40 SFP	CAPPED	1"	BDC 600	>3.8"	48.8-9.8 ft	15.5 oz	12.2"
			Center X				
3-15x40 SFP	CAPPED	1"	BDC 600	>3.8"	30.4-6.3 ft	16.5 oz	12.3"
			Center X				
4-20x50 SFP	CAPPED	1"	BDC 600	>3.8"	23.6-4.7 ft	19.5 oz	13.1"
			AHMR1 SFP MOA				
6-30x56 SFP	CAPPED	30mm	BDC 600	>3.8"	16.6-5.4 ft	23.7oz	14.7"
			AHMR1 SFP MOA				

TALOS^{BTR} [TACTICAL]



Key Features:



Fully Multi-Coated lenses bring you better light transmission to bring optimum brightness and true color across the entire light spectrum.



Waterproof to protect the binocular in the harshest weather conditions or if accidentally submerged underwater.



1-4x24

Nitrogen purging dramatically reduces the moisture inside the tube and helps maintaining fogproof and waterproof.



4-14x44

OTHER FEATURES: Side Parallax Adjustment, 6063 Aluminum - 30mm Tubes, Illuminated Glass Reticles, Exposed Turrets, First/Second Focal Plane

— FFP reticles — SFP reticles

If you ask any hunter they'll tell they probably have filled more tags in the low-light hours than any other time. With that said, it would be wise to design a scope to excel in early-morning and late-evening light. With the Talos BTR cope with Athlon Advanced multi-coated lenses for clarity and brightness in low light, you'll be able to add precious minutes to every hunting day that you've worked hard for. These scopes, with their 4X magnification range, will give you great versatility whether you are hunting whitetails in the dense southern pine forest of Georgia or prairie dogs in on the wide open ranges of Wyoming.

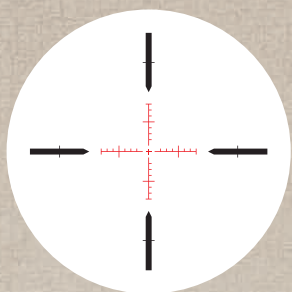

AHSR14 SFP IR MIL

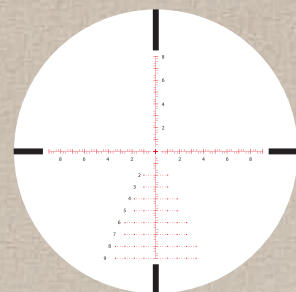

APLR2 FFP IR MIL

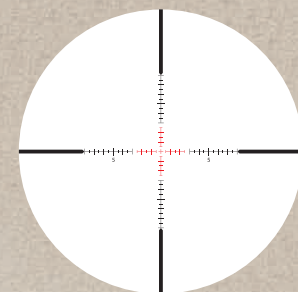

ATMR1 SFP IR MIL

TALOS BTR reticles

TALOS



Key Features:



Fully Multi-Coated lenses bring you better light transmission to bring optimum brightness and true color across the entire light spectrum.



Waterproof to protect the binocular in the harshest weather conditions or if accidentally submerged underwater.



3-12x40



4-16x40



6-24x50

Nitrogen purging dramatically reduces the moisture inside the tube and helps maintaining fogproof and waterproof.

OTHER FEATURES: Side Parallax Adjustment, 6063 Aluminum - 1 inch Tubes, Illuminated Glass Reticles, Capped Turrets, Second Focal Plane

— SFP reticles

If you ask any hunter they'll tell they probably have filled more tags in the low-light hours than any other time. With that said, it would be wise to design a scope to excel in early-morning and late-evening light. With the Talos scope with Athlon Advanced multi-coated lenses for clarity and brightness in low light, you'll be able to add precious minutes to every hunting day that you've worked hard for. These scopes, with their 4X magnification range, will give you great versatility whether you are hunting whitetails in the dense forest or prairie dogs in on the wide open ranges. With one-piece tube design, the Talos line includes an assortment of specialty scopes for big-game, varmint, MSR's, 22 rimfire, slug, black powder and turkey hunting.

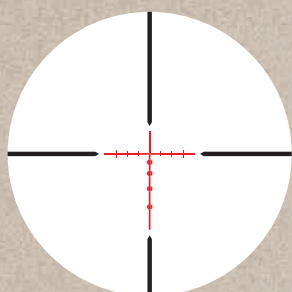

BDC 600 IR

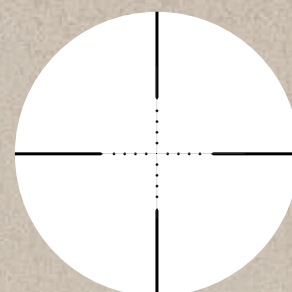

MIL-DOT

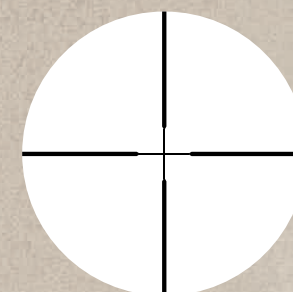

CENTER X

RIFLESCOPES TALOS

TALOS reticles

TALOS^{BTR} SPECIFICATIONS

POWER X OBJECTIVE LENS	TURRET STYLE	TUBE SIZE	AVAILABLE RETICLES	EYE RELIEF	FOV@100 YARDS	WEIGHT	LENGTH
1-4x24 SFP	EXPOSED	30mm	AHSR 14 SFP IR MIL	6.26-3.5"	24.6-9.2 ft	19 oz	9.45"
4-14x44 FFP	EXPOSED	30mm	APLR2 FFP IR MIL	3.23-3.15"	27.2-7.85 ft	23.5 oz	12.5"

TALOS SPECIFICATION

POWER X OBJECTIVE LENS	TURRET STYLE	TUBE SIZE	AVAILABLE RETICLES	EYE RELIEF	FOV@100 YARDS	WEIGHT	LENGTH
3-12x40 SFP	CAPPED	1"	BDC 600 IR	3.82-3.35"	34.1-8.9 ft	16.2 oz	12"
			Center X				
			Mil-Dot				
4-16x40 SFP	CAPPED	1"	BDC 600 IR	3.8-3.35"	24.1-6.28 ft	19.1 oz	12.9"
			Mil-Dot				
6-24x50 SFP	CAPPED	1"	ATMR1 SFP IR MIL	3.03-3.11"	16.76-4.45 ft	23 oz	13.9"
			BDC 600 IR				

NEOS



Increasing your success while hunting doesn't necessarily have to decrease your savings account. The perfect example of that is the Neos series. This is the perfect scope for those who want quality and features all while staying on budget. The Neos has an impressive list of features and is designed and built to endure. It has a one piece aluminum tube. The lenses are Fully Multi Coated. Finally some of the models even have the latest side parallax focus technology. What about the cost? Let's just say the scope isn't the only thing that looks good, but still with optics, ruggedness and precision we are proud of.



3-9x40



4-12x40



6-18x44



Fully Multi-Coated lenses bring you better light transmission to bring optimum brightness and true color across the entire light spectrum.



Waterproof to protect the binocular in the harshest weather conditions or if accidentally submerged underwater.

Nitrogen purging dramatically reduces the moisture inside the tube and helps maintaining fogproof and waterproof.

Second Focal Plane reticle is located at the second plane which stays in between erector tube and ocular lense. The size or the appearance of a second focal plane reticle does not change when you try to zoom in or zoom out.

OTHER FEATURES:
Side Parallax Adjustment, 6063 Aluminum - 1 inch Tubes, Illuminated Glass Reticles, Capped Turrets

— SFP reticles

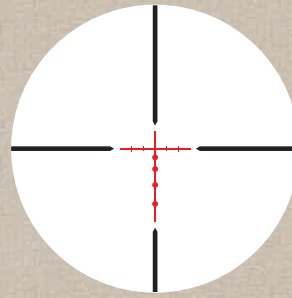

BDC 500 IR

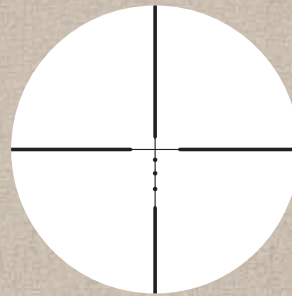

BDC 22 RIMFIRE

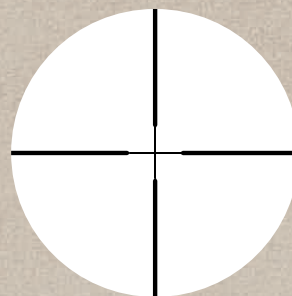

CENTER-X

NEOS RIFLESCOPE SPECIFICATION

POWER X OBJECTIVE LENS	TURRET STYLE	TUBE SIZE	AVAILABLE RETICLES	EYE RELIEF	FOV@100 YARDS	WEIGHT	LENGTH
3-9x40 SFP	CAPPED	1"	Center-X	2.99-3.07"	37.75-12.57 ft	16.1 oz	12.5"
			BDC 500 IR				
			BDC 22 Rimfire				
4-12x40 SFP	CAPPED	1"	Center X	3.11-3.15"	27.25-8.9 ft	16.1 oz	12.5"
			BDC 500 IR				
6-18x44 SFP	CAPPED	1"	Center X	3.39-3.19"	17.49-5.86 ft	16.5 oz	13.5"
			BDC 500 IR				





CRONUS SPOTTING SCOPE SPECIFICATIONS

MAGNIFICATION X OBJECTIVE LENS	EYEPIECE ANGLE	EYE RELIEF	CLOSE FOCUS	FOV @1000 YARDS	WEIGHT	LENGTH X WTDH
20-60x86 ED	45	0.78"	29.5'	117-60 ft	66.5 oz	13.6x3.9"
12-36x50 ED	45	0.7"	26.2'	171-90 ft	26.5 oz	9.8x2.6"

CRONUS



You've just adjusted focus on what had once been only an elusive lifelong quest- an Alaskan Bighorn or a red-throated pipit. We developed the Cronus to give you one of world's best spotting scopes with brighter and clearer edge-to-edge detail. So whether you're hunting above timberline in Alaska or birding at sea level at Cape May, you will know every detail of your trophy before you take the shot or mark it off your life list. The Cronus product line has just about every feature you would put in a scope to make it the best you can get in

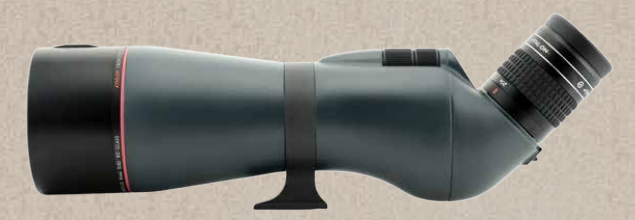
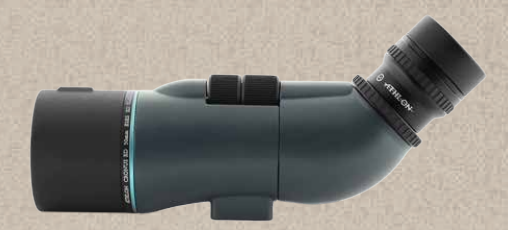

12-36x50 ED

20-60x86 ED



Apochromatic lens system gives you the result of images which have greater contrast, sharpness and color definition.



Argon purging gives you better waterproofing and thermal stability



ED glass gives you an image with little or no chromatic fringe for a clearer and sharper image



XPL Coating gives you an extra protection on the exterior lenses from dirt, oil and scratches



ESP Dielectric Coating is a multi layer prism coating that reflects over 99% of the light to your eyes bringing you a clear, bright image that displays accurate color reproduction.



Bak-4 glass prisms reflect more light to your eyes thus will give you brighter and sharper image.



Waterproof to protect the binocular in the harshest weather conditions or if accidentally submerged underwater.



Advanced Fully Multi-Coated lenses deliver the highest level of light transmission for maximum brightness and true color across the entire light spectrum.

OTHER FEATURES:
Magnesium Chassis, Dual Focus, Rotating Ring

its class. We designed the Cronus with Apochromatic system to give you images that have greater contrast, sharpness and color definition. We included ED Glass that results in clearer and sharper image to your eyes. Our state of the art ESP (Enhance Spectral Prism) dielectric coating that reflects 99% of the light through the prism assembly. Other design enhancements include BaK-4 prisms and our "Advanced Fully Multi-Coated" lenses that deliver flawless color fidelity, ultra-crisp images and optimum light transmission. Finally we topped off with our XPL Lenses coating that protects the exterior lenses from scratches, dust and anything else mother nature throws at you.



WITH APOCHROMATIC LENS SYSTEM



WITHOUT APOCHROMATIC LENS SYSTEM

ARES

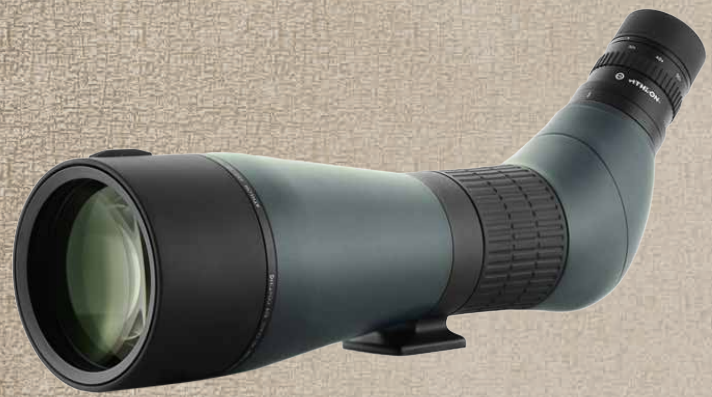

The Ares family of spotting scopes were designed with advanced optical quality and ease of use on top of mind, so when you are trying to collect that trophy of a lifetime, your spotting scope is one thing you don't have to worry about. We made that task as easy as optically possible with bright, razor-sharp imagery and a rugged, weatherproof design that's ready for any condition. They have ED glass



7.5-22.5x50 ED



15-45x65 ED



20-60x85 ED



Apochromatic lens system gives you the result of images which have greater contrast, sharpness and color definition.



Argon purging gives you better waterproofing and thermal stability



ED glass gives you an image with little or no chromatic fringe for a clearer and sharper image



XPL Coating gives you an extra protection on the exterior lenses from dirt, oil and scratches



ESP Dielectric Coating is a multi layer prism coating that reflects over 99% of the light to your eyes bringing you a clear, bright image that displays accurate color reproduction.



Bak-4 glass prisms reflect more light to your eyes thus will give you brighter and sharper image.



Waterproof to protect the binocular in the harshest weather conditions or if accidentally submerged underwater.



Advanced Fully Multi-Coated lenses deliver the highest level of light transmission for maximum brightness and true color across the entire light spectrum.

OTHER FEATURES:
Magnesium Chassis (85mm), Rotating Ring

lenses for color resolution and contrast. They also have our AFMC (Advance Fully Multi-Coatings) and feature Bak4 prisms with the new ESP Dielectric Coating. They bring super-premium clarity and brightness within the reach of most avid enthusiasts. The tough chassis is fog proof and waterproof and filled with Argon gas to prevent internal fogging and for better thermal stability. The lens are then treated externally with our XPL coating to withstand dirt, oil and grime of constant use as well as standing up to harshest weather conditions. Choose from three different models - each distinctly different in size so you have a scope tailor-made for your specific activity.



WITH ED GLASS



WITHOUT ED GLASS

ARES SPOTTING SCOPE SPECIFICATIONS

MAGNIFICATION X OBJECTIVE LENS	EYEPIECE ANGLE	EYE RELIEF	CLOSE FOCUS	FOV @1000 YARDS	WEIGHT	LENGTH X WTDH
20-60x85 ED	45	0.78"	29.5'	102-51 ft	66.5 oz	15.7x3.9"
15-45x65 ED	45	0.78"	13.1'	171-81 ft	43.4 oz	9.5x3.5"
7.5-22.5x50 ED	45	0.62"	13.1'	265-116 ft	18.9 oz	6.9x2.3"

TECHNICAL INFORMATION

CRONUS RIFLESCOPE

Cronus riflescopes are built on ultra-strong one-piece tubes, equipped with a 6x magnification ratio which eliminated the need for multiple scopes for different game or types of hunting. The advanced HD optical system along with our XPL coatings and argon purged waterproofing makes this scope one of a kind.

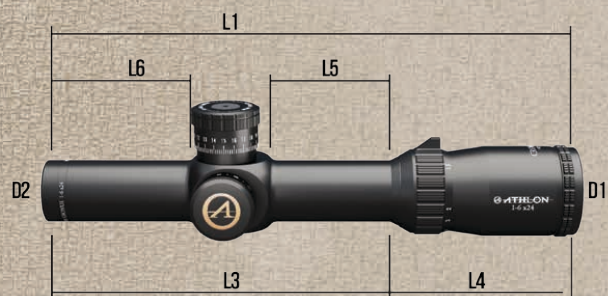

ATSR16 FFP IR MOA reticle has a 2 moa illuminated center cross and 20 moa illuminated center circle, which offers great low light visibility and help you quickly lock in your target and set holdover positions. The illuminated 20-moa-span center circle and a 2 moa center cross with regular 2 moa incremental hash marks extended to 30 moa at each direction on both vertical and horizontal lines provides an unique two layer visual reference that helps the shooter quickly locate the target and lock it on the center within a blink of an eye.

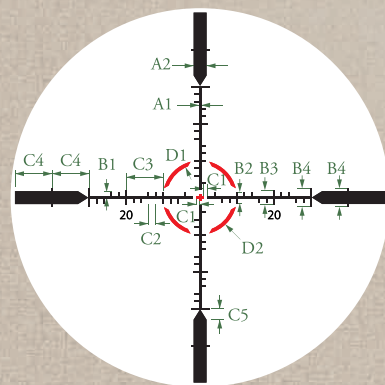

ATSR16 FFP IR MOA

ATSR16 FFP IR MIL reticle is designed to maximize your performance on short and mid-range shooting with an illuminated 10 mil diameter circle that offers great low light visibility, 1 mil center cross and cross lines with 0.5 mil hash mark incremental. The reticle at 1x becomes a red dot circle that can be used effectively for short range target, while at 6x it offers greater details with 0.5 mil hash mark that will help shooters quickly spot their target and set holdover positions.

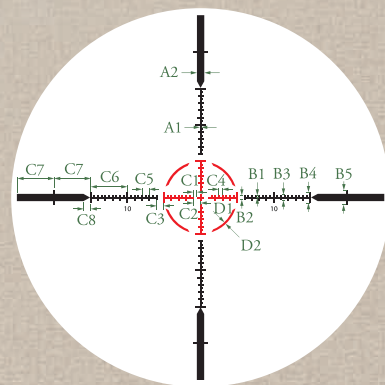

ATSR16 FFP IR MIL

RIFLESCOPE DIMENSIONS

** dimensions are given in inches

RIFLESCOPE MODEL	L1	L2	L3	L4	L5	L6	D1	D2
1-6x24 FFP	10.4	/	6.6	3.8	2.2	2.7	1.8	1.2

RETICLE SUBTENSIONS

ATSR16 FFP IR MOA	A1	A2	B1	B2	B3	B4	C1	C2	C3	C4	C5	D1	D2				
SUBTENSIONS IN MOA	4	3.5	1.5	3	4	5	1	2	10	10	3	18	20				
ATSR16 FFP IR MIL	A1	A2	B1	B2	B3	B4	B5	C1	C2	C3	C4	C5	C6	C7	C8	D1	D2
SUBTENSIONS IN MIL	.17	1	.3	.6	.8	1.5	2	.5	1	1	.5	1	5	5	1	9.4	10

RIFLESCOPE DETAILED SPECS

POWER X OBJECTIVE LENS	TURRET STYLE	TUBE SIZE	AVAILABLE RETICLES	SURFACE FINISH	EYE RELIEF	FOV @100 YARDS	WEIGHT	LENGTH	CLICK VALUE	ADJ. RANGE PER ROTATION	TOTAL ELEV. ADJ.	TOTAL WINDAGE ADJ.	PARALLAX ADJ.	PURGING MATERIAL
1-6X24 FFP	CAPPED EXPOSED	30mm	ATSR16 FFP IR MOA ATSR16 FFP IR MIL	MATTE	3.9"	95-16 ft	19 oz	10.4"	0.5 MOA 0.2 MIL	50 MOA 20 MIL	160 MOA 50 MIL	160 MOA 50 MIL	FIXED 100 yds	ARGON

ATSR16 FFP IR MOA 1X
6X

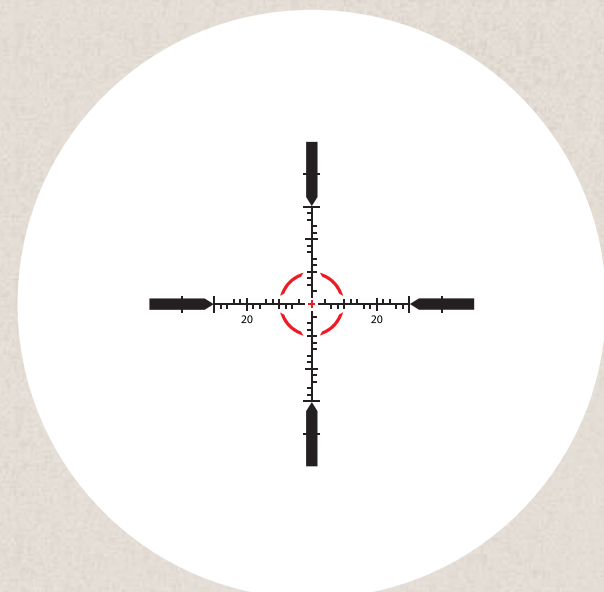
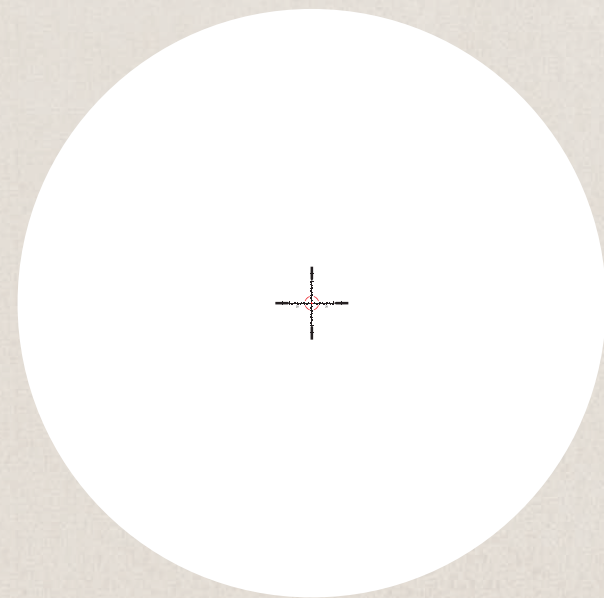

ATSR16 FFP IR MIL 1X
6X

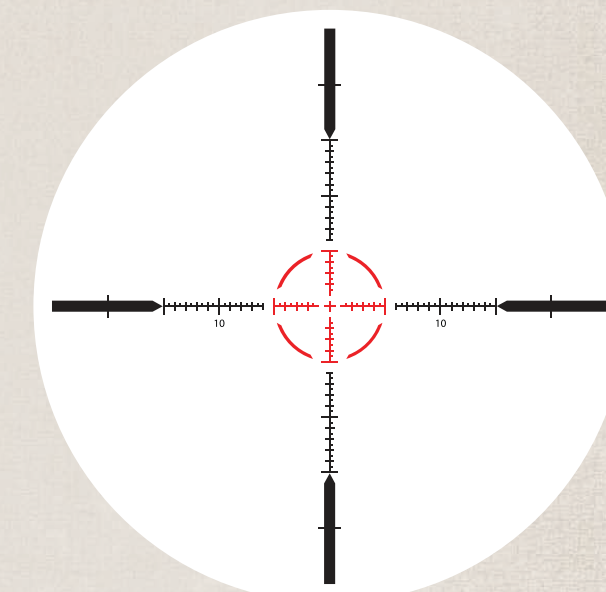
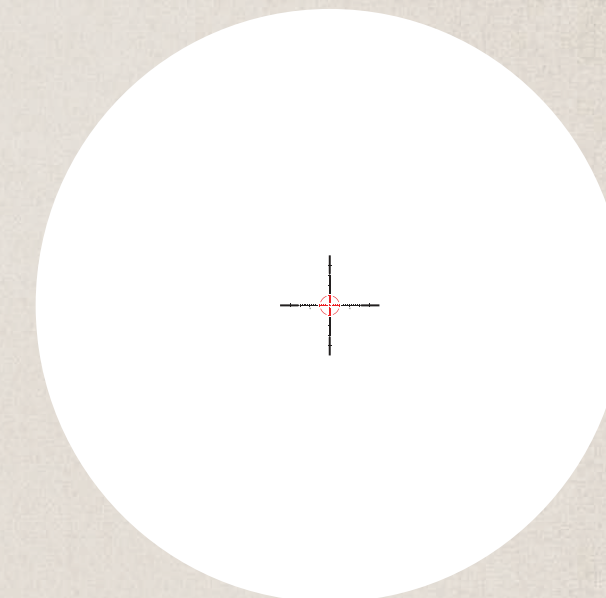

TECHNICAL INFORMATION

CRONUS RIFLESCOPE

Cronus riflescopes are built on ultra-strong one-piece tubes, equipped with a 6x magnification ratio which eliminated the need for multiple scopes for different game or types of hunting. The advanced HD optical system along with our XPL coatings and argon purged waterproofing makes this scope one of a kind.

APLR FFP IR MOA reticle has a large illuminated center with 1 moa incremental hash marks and drop lines in 5 moa incremental on vertical direction down to 50 moa, which help you quickly lock in your target and set holdover positions. The illuminated portion has a 2 moa center cross and 40 moa cross lines (50 moa on lower vertical line). The drop lines have smaller dots with 1 moa in between and bigger dots at each 5 moa interval. The illuminated reticle provides excellent low light visibility and accurate elevation holdovers all the way up to 50 moa.

APLR FFP IR MIL reticle is designed to maximize your performance on precision long-distance shooting with accurate ranging capability. The reticle can help you quickly determine distance, holdover positions, windage correction and leads for a moving target. Having .2 & .4 Mil and .6 and .8 Mil on different side of cross lines helps a shooter quickly locate a holdover position within a blink of an eye. The illuminated fine reticle provides excellent low light visibility and windage holdovers on the bullet droplines all the way up to 10 mils with .2 mil mark incremental.

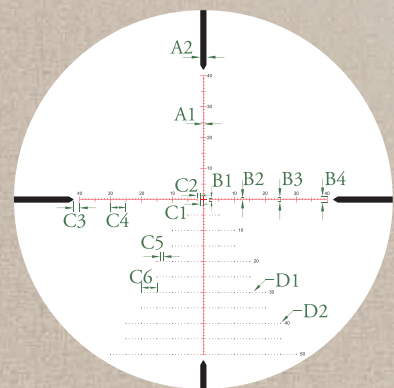
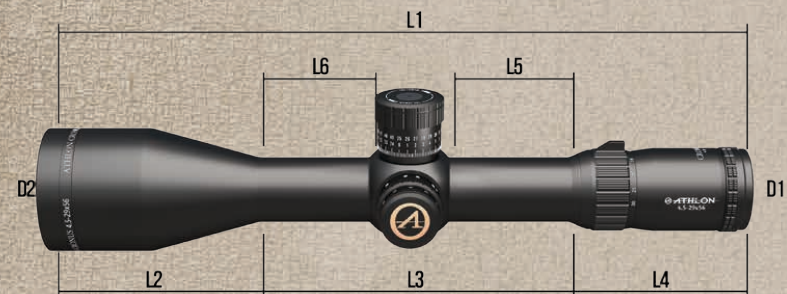

APLR FFP IR MOA

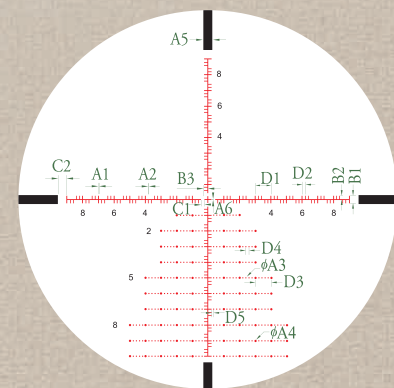

APLR FFP IR MIL

RIFLESCOPE DIMENSIONS

** dimensions are given in inches

RIFLESCOPE MODEL	L1	L2	L3	L4	L5	L6	D1	D2
4.5-29x56 FFP	14.4	3.9	6.3	4.2	2.6	2	1.8	2.6

RETICLE SUBTENSIONS

APLR FFP IR MOA	A1	A2	B1	B2	B3	B4	C1	C2	C3	C4	C5	C6	D1	D2		
SUBTENSIONS IN MOA	.14	2	1	.5	1.5	2	1	1	2	5	1	5	.2	.3		
APLR FFP IR MIL	A1	A2	A3	A4	A5	A6	B1	B2	B3	C1	C2	D1	D2	D3	D4	D5
SUBTENSIONS IN MIL	.03	.02	.05	.1	.5	.025	.4	.2	.2	.2	.5	1	.2	1	.2	.2

RIFLESCOPE DETAILED SPECS

POWER X OBJECTIVE LENS	TURRET STYLE	TUBE SIZE	AVAILABLE RETICLES	SURFACE FINISH	EYE RELIEF	FOV @100 YARDS	WEIGHT	LENGTH	CLICK VALUE	ADJ. RANGE PER ROTATION	TOTAL ELEV. ADJ.	TOTAL WINDAGE ADJ.	PARALLAX ADJ.	PURGING MATERIAL
4.5-29X56 FFP	EXPOSED	34mm	APLR FFP IR MOA APLR FFP IR MIL	MATTE	3.6-3.8"	46.2-9.9 ft	35.8 oz	14.4"	0.25 MOA 0.1 MIL	25 MOA 10 MIL	110 MOA 33 MIL	60 MOA 18 MIL	SIDE FOCUS 25yds - ∞	ARGON

APLR FFP IR MOA 4.5X
29X

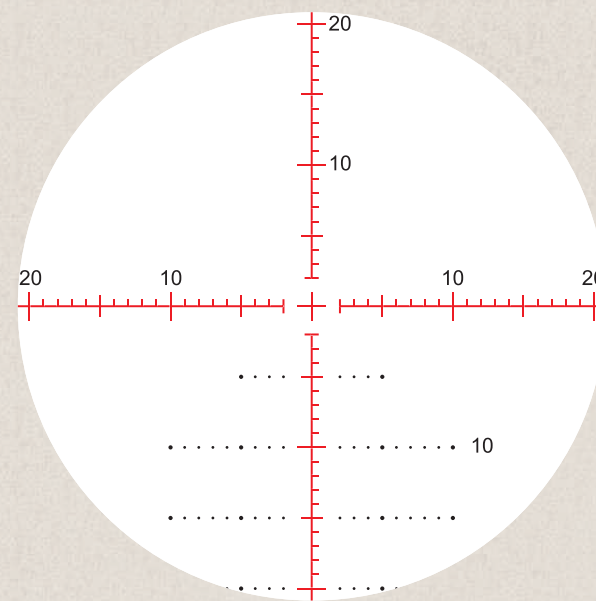
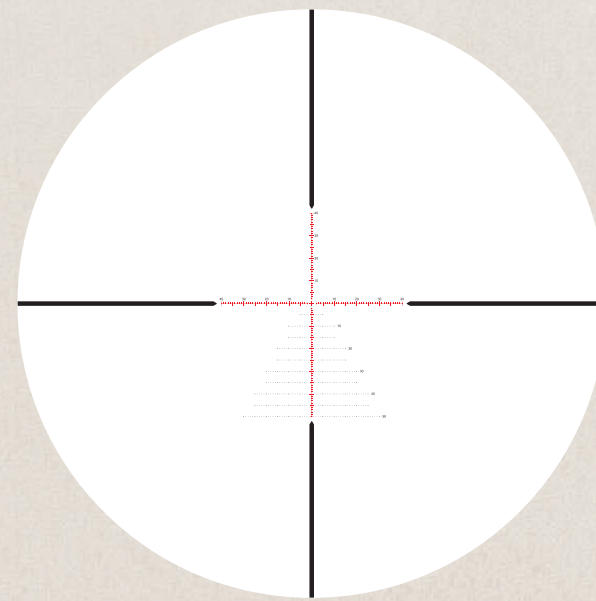

APLR FFP IR MIL 4.5X
29X

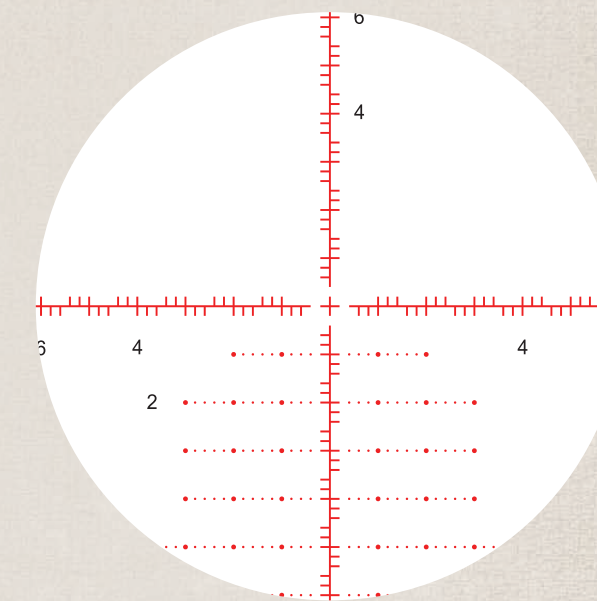
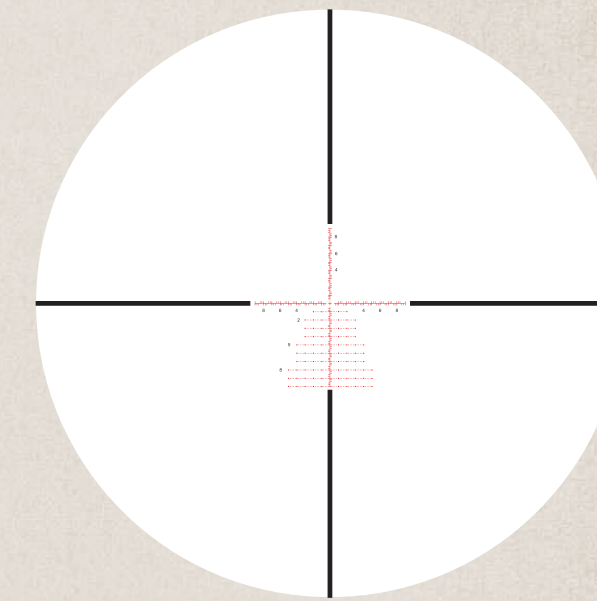

TECHNICAL INFORMATION



MIDAS^{BTR} RIFLESCOPE

The Midas BTR is ready for anything you can throw at it. From tip to tip, this scope has it all. HD glass, FMC optics, XPL coatings, and argon gas purged makes this scope waterproof and fog proof. Add all of these features together and you get an excellent scope that should break the bank, but won't!



RIFLESCOPE DIMENSIONS

RIFLESCOPE MODEL	L1	L2	L3	L4	L5	L6	D1	D2
1-6x24 SFP	10.6	/	7	3.7	2.3	3.5	1.7	1.2
2.5-15x50 SFP	13.8	4.75	5.5	3.5	2	2.38	1.75	2.25
4.5-27x50 SFP	13.8	4.75	5.5	3.5	2	2.38	1.75	2.25

** dimensions are given in inches

ATSR 16 SFP IR MIL reticle is designed to maximize your performance on short and mid-range shooting with illuminated center cross and 0.5 mil hash marks incremental extended to 5 mils. The illuminated 10 mil center with a 0.5 mil center cross and 0.5 mil hash marks provide a unique two layer visual reference. The illuminated portion of the reticle provides excellent low light visibility and the total 30 mil reticle span with 0.5 mil incremental offers accurate holdover positions.

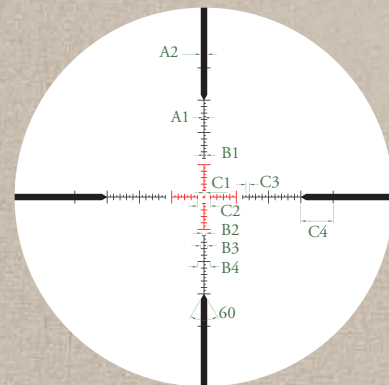

ATSR16 SFP IR MIL

ATSR16 SFP IR MOA reticle has a large illuminated center and 2 moa incremental hash marks, which help you quickly lock in your target and set holdover positions. The illuminated center with a 20 moa diameter circle in the middle has a 2 moa center cross and 2 moa incremental hash marks extended to 30 moa at each direction on both vertical and horizontal lines. The cross lines, middle circle, and center cross provide a unique three layer visual reference for a shooter to locate the target and set dead on the center cross within a blink of an eye.

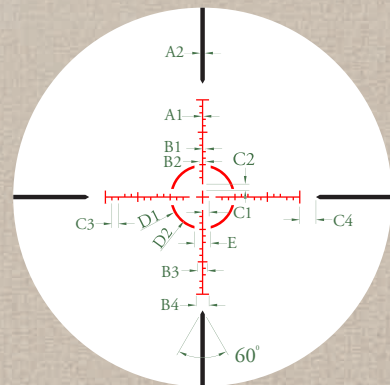

ATSR16 SFP IR MOA

AHMR SFP IR MOA reticle has an illuminated 20 moa center with a 2 moa center cross and 2 moa incremental hash marks which provide a unique two layer visual reference for a shooter to locate and get dead on the target within a blink of an eye. The illuminated reticle provides excellent low light visibility. The unique design of the markings with 2 & 4 moa and 6 & 8 moa locating at the opposite side of the lines gives you a clear reading of the markings with no confusions.

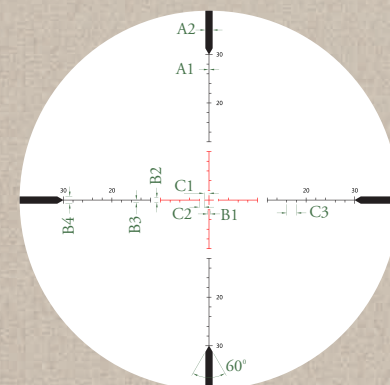

AHMR SFP IR MOA

APMR1 SFP IR MIL reticle is designed to maximize your performance on mid-distance shooting with illuminated center cross and 0.5 mil hash marks which provides excellent low light visibility. The illuminated 4 mil span center cross with 0.5 mil hash mark and extended 5 mil marks provide a unique two layer visual reference for a shooter quickly locate the target and find a holdover position.

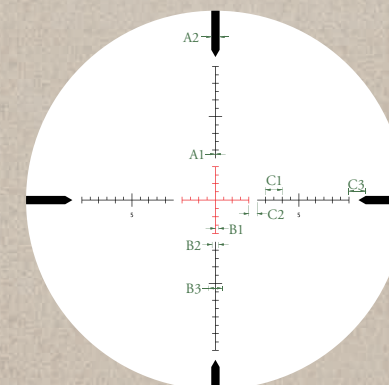

APMR1 SFP IR MIL

APLR1 SFP IR MIL reticle is designed for precision long-distance shooting with accurate ranging capability and helps you quickly determine distance, holdover positions, windage corrections and leads for a moving target. Having .2 & .4 mil and .6 & .8 mil on different side of cross lines helps a shooter quickly locate a holdover position with no confusion. The illuminated fine reticle provides excellent low light visibility and windage holdovers on the bullet droplines all the way up to 9 mils with .2 mil marks incremental in between.

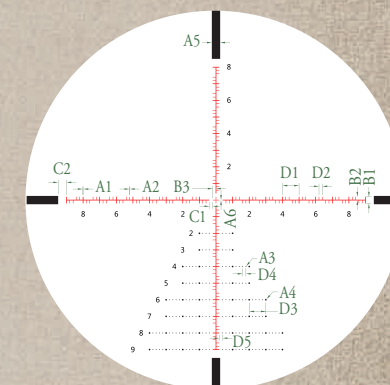

APLR1 SFP IR MIL

RETICLE SUBTENSIONS

ATSR16 SFP IR MIL	A1	A2	B1	B2	B3	B4	C1	C2	C3	C4
SUBTENSIONS IN MIL	.12	1	.3	.6	1	2	.25	2	.25	5

ATSR16 SFP IR MOA	A1	A2	B1	B2	B3	B4	C1	C2	C3	C4	D1	D2	E
SUBTENSIONS IN MOA	.4	1.38	1	2	3	4	2	2	2	5	20	18.5	5

AHMR SFP IR MOA	A1	A2	B1	B2	B3	B4	C1	C2	C3
SUBTENSIONS IN MOA	.12	1.5	.5	1	.5	1.5	1	1	2

APMR1 SFP IR MIL	A1	A2	B1	B2	B3	C1	C2	C3
SUBTENSIONS IN MIL	.04	.5	.2	.4	.8	1	.5	1

APLR1 SFP IR MIL	A1	A2	A3	A4	A5	A6	B1	B2	B3	C1	C2	D1	D2	D3	D4	D5
SUBTENSIONS IN MIL	.04	.025	.05	0.1	0.5	.025	.1	.2	.2	.2	.5	1	.2	1	.2	.2

RIFLESCOPE DETAILED SPECS

POWER X OBJECTIVE LENS	TURRET STYLE	TUBE SIZE	AVAILABLE RETICLES	SURFACE FINISH	EYE RELIEF	FOV @100 YARDS	WEIGHT	LENGTH	CLICK VALUE	ADJ. RANGE PER ROTATION	TOTAL ELEV. ADJ.	TOTAL WINDAGE ADJ.	PARALLAX ADJ.	PURGING MATERIAL
1-6X24 SFP	CAPPED	30mm	ATSR16 SFP IR MOA	MATTE	3.8"	108-17.6 ft	18.1 oz	10.6"	0.5 MOA	30 MOA	150 MOA	150 MOA	FIXED 100 yds	ARGON
			ATSR16 SFP IR MIL						0.2 MIL	12 MIL	40 MIL	40 MIL		
2.5-15X50 SFP	EXPOSED	30mm	AHMR SFP IR MOA	MATTE	3.9"	41.8-6.8 ft	21.4 oz	13.8"	0.25 MOA	15 MOA	60 MOA	60 MOA	SIDE FOCUS 30yds - ∞	ARGON
			APMR1 SFP IR MIL						0.1 MIL	6 MIL	18MIL	18 MIL		
			AHMR SFP IR MOA						0.25 MOA	15 MOA	60 MOA	60 MOA		
4.5-27X50 SFP	EXPOSED	30mm	APMR1 SFP IR MIL	MATTE	3.9"	22.7-3.6 ft	21.4 oz	13.8"	0.1 MIL	6 MIL	18 MIL	18 MIL	SIDE FOCUS 30yds - ∞	ARGON
			APLR1 SFP IR MIL											

* Reticle subtension valid @6x, 15x

TECHNICAL INFORMATION



ARGOS^{BTR} RIFLESCOPE

The Argos BTR riflescope is reporting for duty. This first focal plane scope gives you easy elevation and windage adjustments, packaged with the advanced Fully-Multi Coated Optics deliver crystal clear bright images in any light scenario. Add the side parallax adjustments to the Argos scope which gives you the ability to adjust to any range right at your fingertips, gives you one heck of a riflescope.

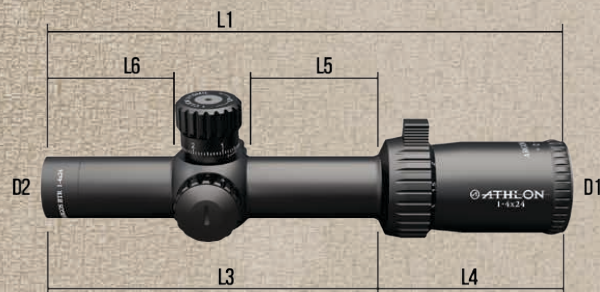

AHSR14 FFP IR MOA reticle has an illuminated 20 moa diameter circle with a 2 moa center cross and 2 moa incremental hash marks. The cross lines, middle circle, and center cross provide a unique three layer visual reference that draws shooters' vision right into the center. The illuminated portion of the reticle provides excellent low light visibility and accurate elevation holdovers all the way up to 30 moa with 2 moa marks incremental.

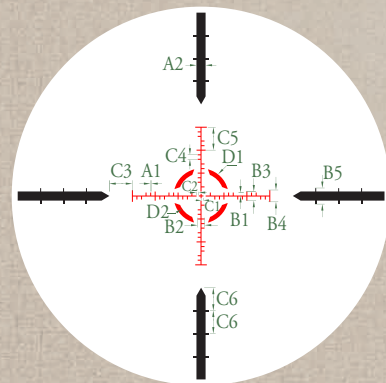

AHSR14 FFP IR MOA

AHSR 14 FFP IR MIL reticle is designed to maximize your performance on short and mid-range shooting with an illuminated 16 mil diameter circle, 1 mil center cross, and cross lines with 1mil hash mark incremental extended to 8 mils on both horizontal and vertical directions. The reticle at 1x becomes a red dot circle for short range target, while it offers enough details at 4x to help shooters quickly spot their target and set holdover positions.

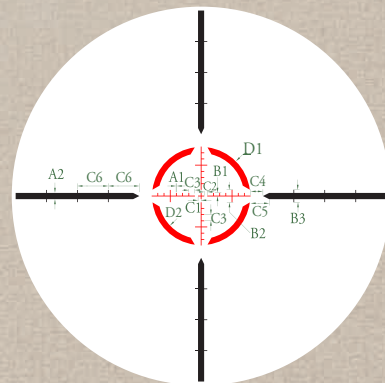

AHSR14 FFP IR MIL

RIFLESCOPE DIMENSIONS

** dimensions are given in inches

RIFLESCOPE MODEL	L1	L2	L3	L4	L5	L6	D1	D2
1-4x24 FFP	9.8	/	6.2	3.6	2.3	2.4	1.8	1.2

RETICLE SUBTENSIONS

AHSR14 FFP IR MOA	A1	A2	B1	B2	B3	B4	B5	C1	C2	C3	C4	C5	C6	D1	D2
SUBTENSIONS IN MOA	.5	4	1.5	3	4	5	7	1	1	10	2	10	10	12	10
AHSR14 FFP IR MIL	A1	A2	B1	B2	B3	C1	C2	C3	C4	C5	C6	D1	D2		
SUBTENSIONS IN MIL	.13	1	.5	2	2	.5	.5	1	2	3	5	8	7		

RIFLESCOPE DETAILED SPECS

POWER X OBJECTIVE LENS	TURRET STYLE	TUBE SIZE	AVAILABLE RETICLES	SURFACE FINISH	EYE RELIEF	FOV @100 YARDS	WEIGHT	LENGTH	CLICK VALUE	ADJ. RANGE PER ROTATION	TOTAL ELEV. ADJ.	TOTAL WINDAGE ADJ.	PARALLAX ADJ.	PURGING MATERIAL
1-4x24 FFP	EXPOSED	30mm	AHSR14 FFP IR MOA AHSR14 FFP IR MIL	MATTE	3.5"	112-27 ft	20.5 oz	9.8"	0.5 MOA 0.2 MIL	30 MOA 12 MIL	120 MOA 40 MIL	120 MOA 40 MIL	FIXED 100 yds	ARGON

1X
AHSR14 FFP IR MOA
4X

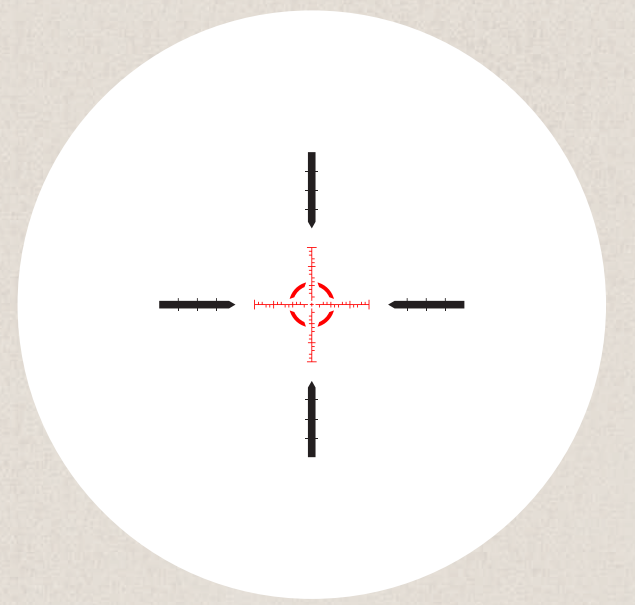
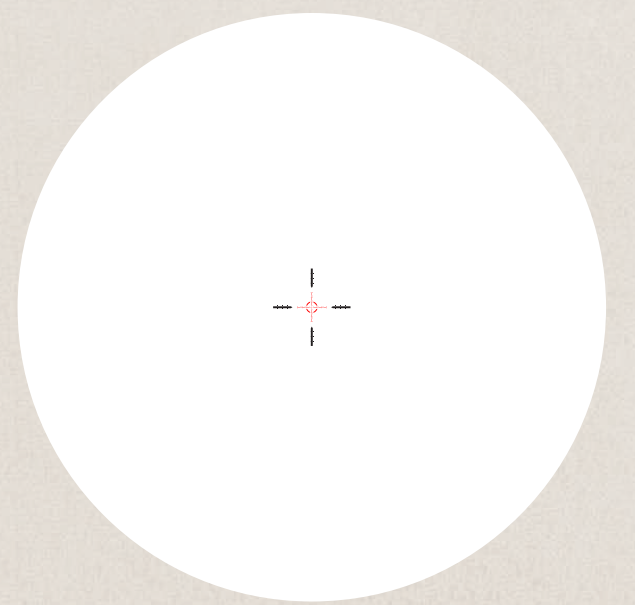

1X
AHSR14 FFP IR MIL
4X

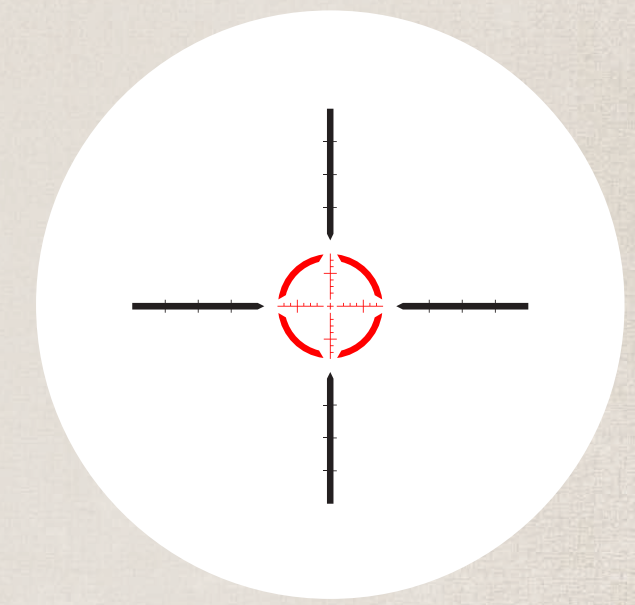
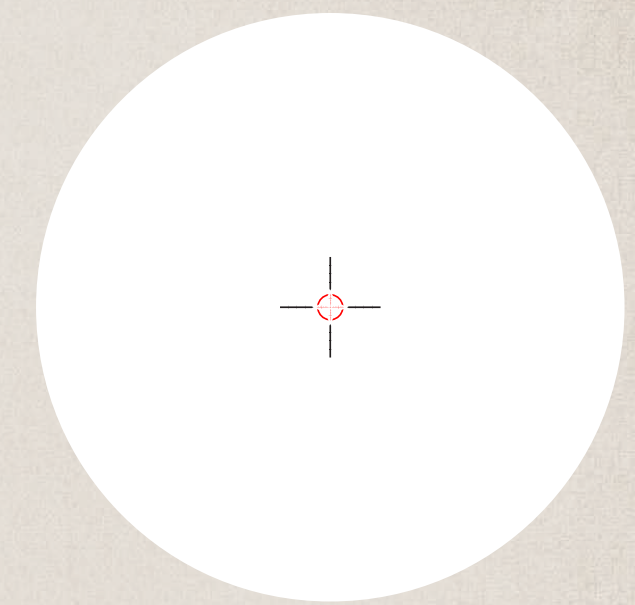

TECHNICAL INFORMATION

ARGOS^{BTR} RIFLESCOPE

The Argos BTR rifle scope is reporting for duty. This first focal plane scope gives you easy elevation and windage adjustments, packaged with the advanced Fully-Multi Coated Optics deliver crystal clear bright images in any light scenario. Add the side parallax adjustments to the Argos scope which gives you the ability to adjust to any range right at your fingertips, gives you one heck of a rifle scope.

ATMR FFP IR MOA reticle has a large illuminated center and 2 moa incremental hash marks, which help you quickly lock in your target and set holdover positions. The illuminated portion has a 2 moa center cross with illuminated vertical cross line extends to 40 moa and all the way to 90 moa on black line with 10 moa incremental markings and the illuminated horizontal cross line extended to 30 moa at each direction. The illuminated reticle provides excellent low light visibility and accurate elevation holdovers all the way up to 40 moa with 2 moa markings incremental.

APMR FFP IR MIL reticle is designed to maximize your performance on long and mid-distance shooting with illuminated center cross and 0.5 mil hash mark, the APMR IR MIL reticle can help you quickly lock in your target and set holdover positions and leads for a moving target. The illuminated 18 mil span cross lines with 0.5 mil hash marks and 0.2 mil hash marks from 7 mil to 9 mil on three directions provide finer details that helps the shooter quickly locate the target and find a holdover position within higher level of precision and confidence.

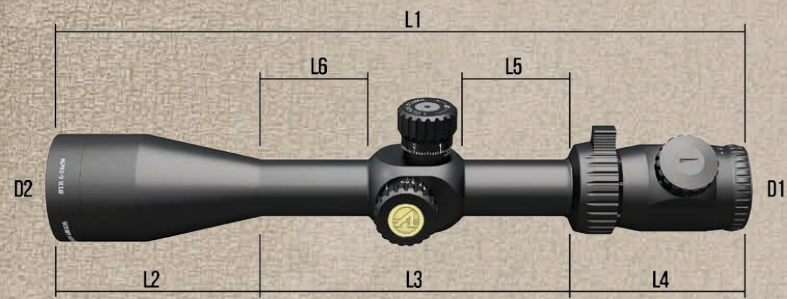

RIFLESCOPE DIMENSIONS

** dimensions are given in inches

RIFLESCOPE MODEL	L1	L2	L3	L4	L5	L6	D1	D2
6-24x50 FFP	14.1	4.2	6.2	3.7	2	2.1	1.8	2.2
8-34x56 FFP	15.5	4.96	6.93	3.66	1.97	2.87	2.50	1.81

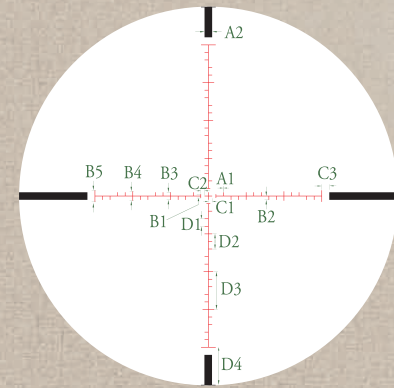

ATMR FFP IR MOA

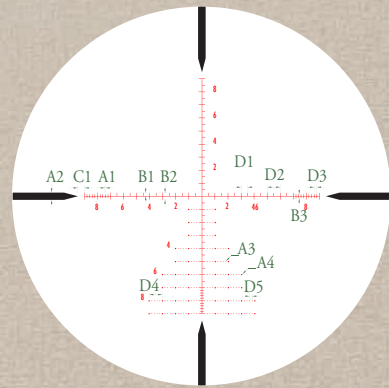

APMR FFP IR MIL

RETICLE SUBTENSIONS

APMR FFP IR MIL	A1	A2	A3	A4	B1	B2	B3	C1	D1	D2	D3	D4	D5	
SUBTENSIONS IN MIL	.02	.4	.1	.05	.2	.4	.3	2	.5	1	.2	1	.2	
ATMR FFP IR MOA	A1	A2	B1	B2	B3	B4	B5	C1	C2	C3	D1	D2	D3	D4
SUBTENSIONS IN MOA	.14	2	1	1	2	2.5	4	1	1	2	2	4	10	10

RIFLESCOPE DETAILED SPECS

POWER X OBJECTIVE LENS	TURRET STYLE	TUBE SIZE	AVAILABLE RETICLES	SURFACE FINISH	EYE RELIEF	FOV @100 YARDS	WEIGHT	LENGTH	CLICK VALUE	ADJ. RANGE PER ROTATION	TOTAL ELEV. ADJ.	TOTAL WINDAGE ADJ.	PARALLAX ADJ.	PURGING MATERIAL
6-24x50 FFP	EXPOSED	30mm	ATMR FFP IR MOA	MATTE	3.3"	16.7-4.5 ft	29.6 oz	14.1"	0.25 MOA	12 MOA	60 MOA	60 MOA	SIDE FOCUS 10yds - ∞	ARGON
			APMR FFP IR MIL											
8-34x56 FFP	EXPOSED	30mm	ATMR FFP IR MOA	MATTE	3.3"	12.5-3 ft	32.2 oz	15.5"	0.25 MOA	12 MOA	40 MOA	40 MOA	SIDE FOCUS 15yds - ∞	ARGON
			APMR FFP IR MIL											

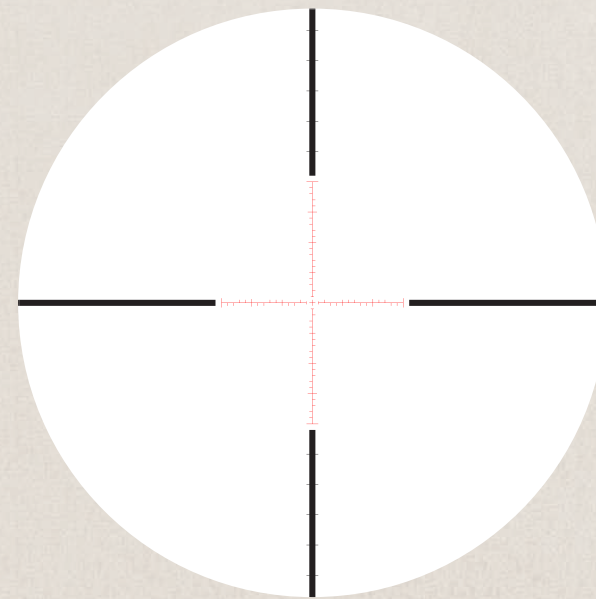

6X

ATMR FFP IR MOA

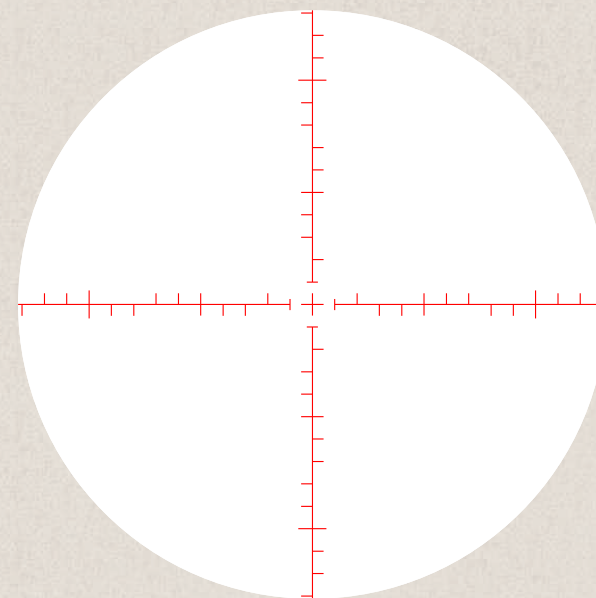

24X

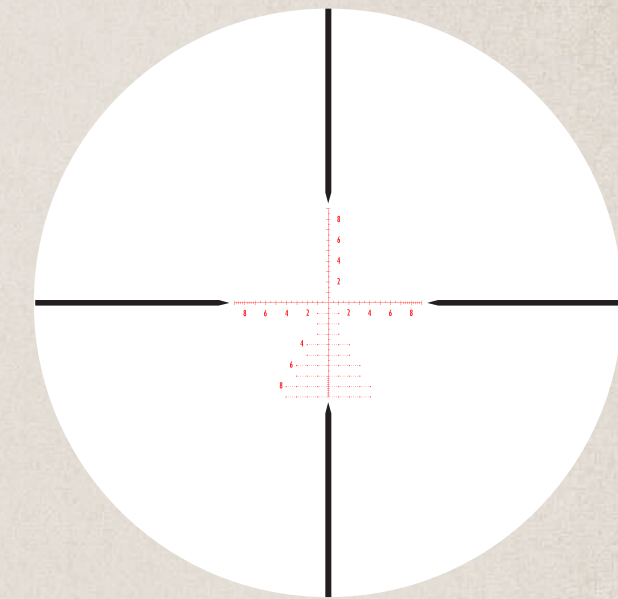

6X

APMR FFP IR MIL

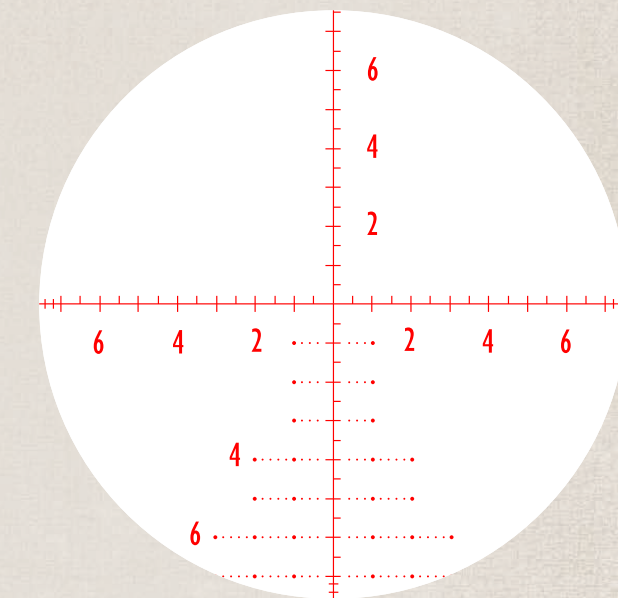

24X

TECHNICAL INFORMATION

ARGOS RIFLESCOPE

The Argos family of scopes is designed for the serious big game hunter. The 5x magnification makes this scope versatile in multiple shooting disciplines from up close targets to long range distances. The fully multicoated optics are protected by the 6061T6 aircraft grade aluminum tube making this scope virtually indestructible. Oh yea, add in our XPL coatings and argon purged, rain, snow or shine, you can count on this scope to perform!

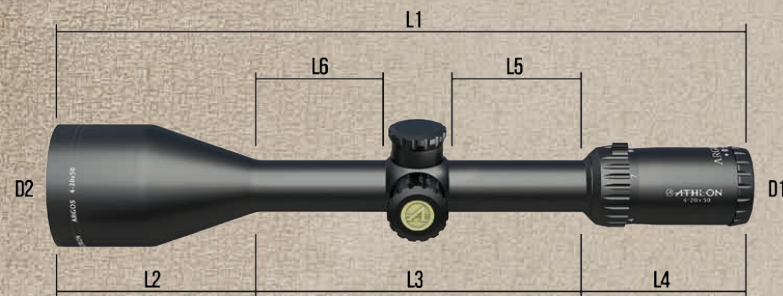

Center X Reticle is a perfect choice for shooters wishing to have a clear field of view with a more traditional crosshair. The Center X reticle allows shooters to quickly view their target while maintaining one distinct aiming point on their reticle. The heavy posts stand out nicely against cover and in twilight conditions, pointing boldly to the intersection.

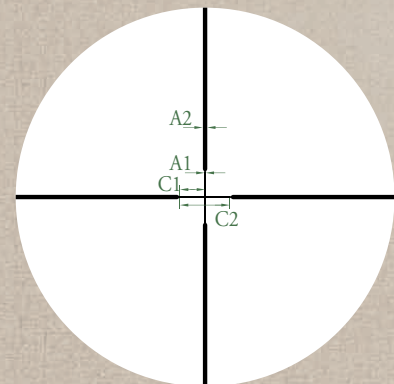

CENTER X

AHMR1 SFP MOA reticle is perfect for hunting and shooting at varying ranges out in the field. The customized Mil hash mark helps to eliminate any guesswork with holdover and windage adjustments. Bottom line, when you need to depend on the shot, this reticle will deliver.

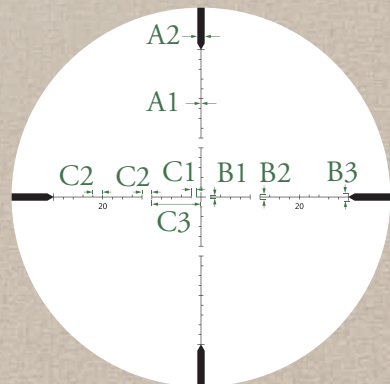

AHMR1 SFP MOA

BDC 600 reticle can be used effectively with a variety of firearms giving your accurate ranges and reference marks which can be used to compensate for bullet drift in windy conditions or range distances. The user can sight in at 100 yards on any magnification setting, but for the ballistic reticle feature to function properly, the scope's magnification must be set to the correct power as follows: 2-10x40 (10x power), and for 3-15x40, 4-20x50 and 6-30x56 (15x power)

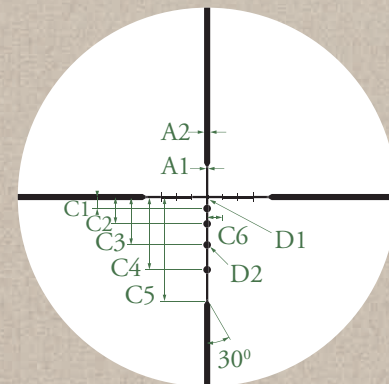

BDC 600

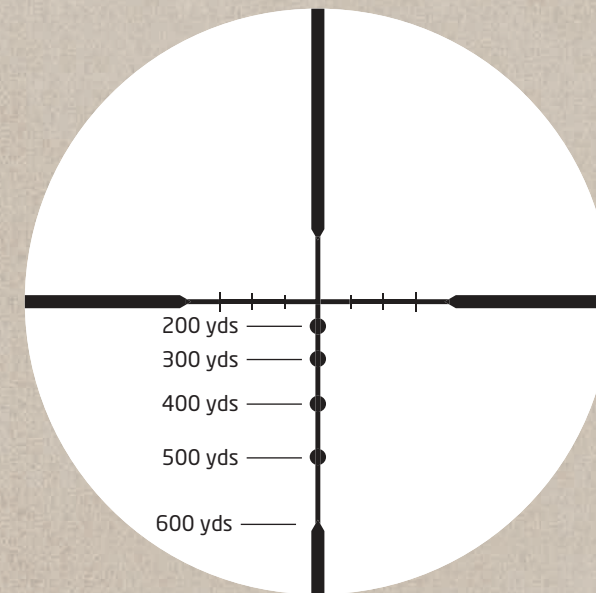

The **BDC 500 IR** will work with any of the following ammunition loads:

.223 Win, 55 gr
.243 Win, 95 gr
25-06 Rem 115 gr
.270 Win, 130 gr
.270 WSM, 150 gr
.7mm Rem Mag, 150 gr
.7mm WSM, 150 gr
.30-06 Sprg, 150 gr
.300 Winchester Mag, 180 gr
300 WSM, 180 gr
.338 Win, 200 gr

RIFLESCOPE DIMENSIONS

RIFLESCOPE MODEL	L1	L2	L3	L4	L5	L6	D1	D2
2-10x40 SFP	12.2	3.1	5.86	3.22	2.58	2.1	1.54	1.92
3-15x40 SFP	12.3	3.1	6.1	3.1	2.58	2.32	1.54	1.92
4-20x50 SFP	13.1	3.86	6.14	3.13	2.55	2.36	1.54	2.36
6-30x56 SFP	14.7	4.9	6.81	3	2.58	2.82	1.54	2.6

** dimensions are given in inches

RETICLE SUBTENSIONS

CENTER X	A1	A2	C1	C2	CONFIGURATION
SUBTENSIONS IN MOA	.21	.63	4.55	9.1	2-10x40
	.14	.42	3.05	6.1	3-15x40

BDC 600	A1	A2	C1	C2	C3	C4	C5	C6	D1	D2
SUBTENSIONS IN MOA	.3	.8	1.5	3.5	6.25	9.5	13.6	2	.2	1

AHMR1 SFP MOA	A1	A2	C1	C2	C3	B1	B2	B3	CONFIGURATION
SUBTENSIONS IN MOA	.13	1.5							4-20X50
	.1	1.2	1	2	10	.5	1	1.5	6-30X56

RIFLESCOPE DETAILED SPECS

POWER X OBJECTIVE LENS	TURRET STYLE	TUBE SIZE	AVAILABLE RETICLES	SURFACE FINISH	EYE RELIEF	FOV @100 YARDS	WEIGHT	LENGTH	CLICK VALUE	ADJ. RANGE PER ROTATION	TOTAL ELEV. ADJ.	TOTAL WINDAGE ADJ.	PARALLAX ADJ.	PURGING MATERIAL
2-10x40 SFP	CAPPED	1"	CENTER X BDC 600	MATTE	>3.8"	48.8-9.8 ft	15.5 oz	12.2"	0.25 MOA	15 MOA	60 MOA	60 MOA	FIXED 100 yds	ARGON
3-15x40 SFP	CAPPED	1"	CENTER X BDC 600	MATTE	>3.8"	30.4-6.3 ft	16.5 oz	12.3"	0.25 MOA	15 MOA	60 MOA	60 MOA	FIXED 100 yds	ARGON
4-20x50 SFP	CAPPED	1"	BDC 600 AHMR1 SFP MOA	MATTE	>3.8"	23.6-4.7 ft	19.5 oz	13.1"	0.25 MOA	15 MOA	50 MOA	50 MOA	SIDE FOCUS 25yds - ∞	ARGON
6-30x56 SFP	CAPPED	30mm	BDC 600 AHMR1 SFP MOA	MATTE	>3.8"	16.6-5.4 ft	23.7 oz	14.7"	0.25 MOA	15 MOA	60 MOA	60 MOA	SIDE FOCUS 25yds - ∞	ARGON

* Reticle subtension valid @10x, 15x

TECHNICAL INFORMATION

TALOS^{BTR} RIFLESCOPE

Let's face it, dawn or dusk are when more tags are filled during low-light situations. The Talos BTR was designed to tackle this problem with our advanced multi-coated lenses for clarity and brightness when you are running out of light. The 4x magnification range will give you great versatility for taking that close shot in dense trees or that long shot in the open ranges.

AHSR 14 SFP IR MIL reticle is designed to maximize your performance on short range shooting with illuminated 1 mil center cross and 1 mil hash marks increments extended to 8 mils on both horizontal and vertical directions and can help you quickly spot your target and set holdover positions and leads for a moving target. The illuminated 16 mil center with an 1 mil center cross (0.5 mil from center to the side) and 10 mil black lines enable a shooter to quickly locate the target and put it right on the center cross within a blink of an eye. The illuminated portion of the reticle provides excellent low light visibility.

APLR2 FFP IR MIL reticle is designed to maximize your performance on precision long and mid range shooting with accurate ranging capability. It will help you quickly determine distance, holdover positions, windage correction and leads for a moving target. The unique design of fine .2 mil hash mark, having .2 and .4 on one side of either horizontal or vertical line and .6 and .8 on another side, helps the shooter quickly locate a holdover position with .2 mil increments within a blink of an eye. The illuminated fine reticle provides excellent low light visibility and windage holdovers on the bullet droplines all the way up to 9 mils with .2 mil marks increments between.

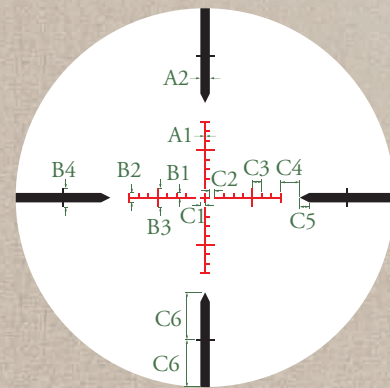

AHSR14 SFP IR MIL

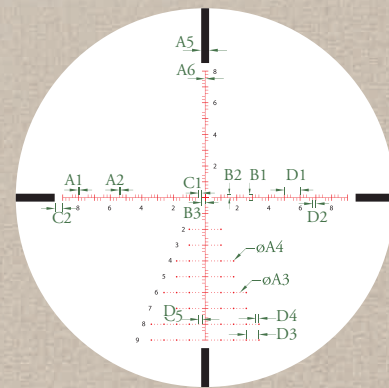

APLR2 FFP IR MIL

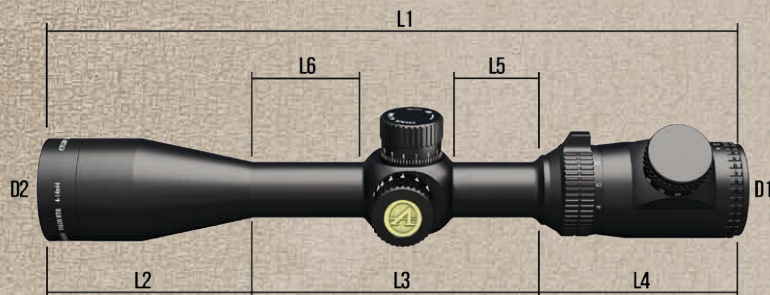

RIFLESCOPE DIMENSIONS

RIFLESCOPE MODEL	L1	L2	L3	L4	L5	L6	D1	D2
1-4X24 SFP	9.45	/	5.79	3.66	1.85	2.60	1.77	1.18
4-14X44 FFP	12.5	3.70	5.00	3.80	1.40	2.00	1.70	1.80

RETICLE SUBTENSIONS

AHSR14 SFP IR MIL	A1	A2	B1	B2	B3	B4	C1	C2	C3	C4	C5	C6
SUBTENSIONS IN MIL	.13	1	.5	1	2	2	.5	.5	1	2	1	5

APLR2 FFP IR MIL	A1	A2	A3	A4	A5	A6	B1	B2	B3	C1	C2	D1	D2	D3	D4	D5
SUBTENSIONS IN MIL	.04	.025	.05	.1	.5	.025	.1	.2	.2	.2	.5	1	.2	1	.2	.2

4X

APLR2 FFP IR MIL

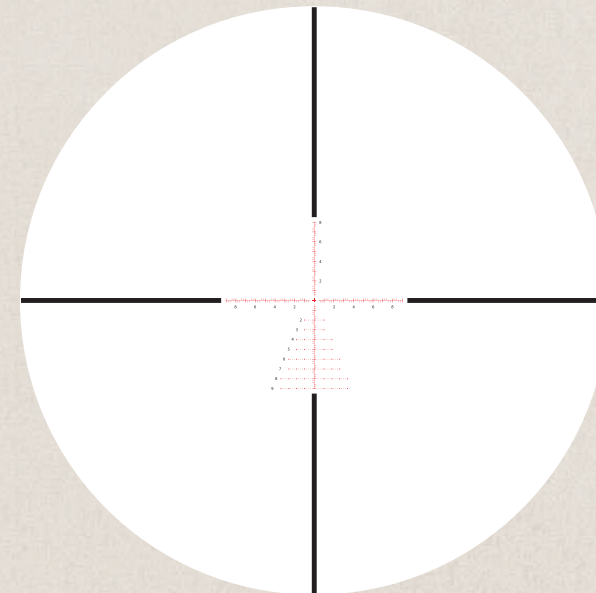

14X

APLR2 FFP IR MIL

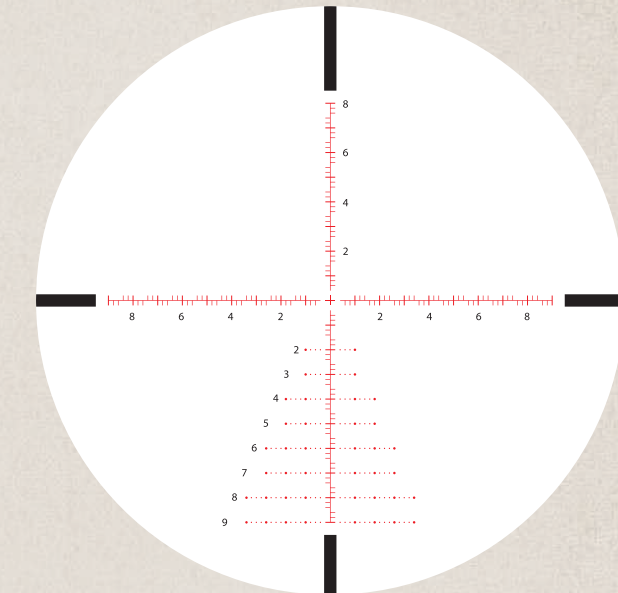

RIFLESCOPE DETAILED SPECS

POWER X OBJECTIVE LENS	TURRET STYLE	TUBE SIZE	AVAILABLE RETICLES	SURFACE FINISH	EYE RELIEF	FOV@100 YARDS	WEIGHT	LENGTH	CLICK VALUE	ADJ. RANGE PER ROTATION	TOTAL ELEV. ADJ.	TOTAL WINDAGE ADJ.	PARALLAX ADJ.	PURGING MATERIAL
1-4X24 SFP	EXPOSED	30mm	AHSR14 SFP IR MIL	MATTE	6.26-3.5"	24.6-9.2 ft	19 oz	9.45"	0.2 MIL	12 MIL	40 MIL	40 MIL	FIXED 100 Yds	NITROGEN
4-14X44 SFP	EXPOSED	30mm	APLR2 FFP IR MIL	MATTE	3.23-3.15"	27.2-7.85 ft	23.5 oz	12.5"	0.1 MIL	5 MIL	18 MIL	18 MIL	SIDE FOCUS 10yds - ∞	NITROGEN

** dimensions are given in inches

TECHNICAL INFORMATION

TALOS RIFLESCOPE

Just like it's brother the Talos BTR product family, the Talos is loaded with the same key features. With 3 different configurations to choose from (3-12x40, 4-16x40, 6-24x50) and 4 reticle selections, the choice is very easy with this one. Performance, reliability, versatile all while not breaking the bank.

Center X Reticle is a perfect choice for shooters wishing to have a clear field of view with a more traditional crosshair. The Center X reticle allows shooters to quickly view their target while maintaining one distinct aiming point on their reticle. The heavy posts stand out nicely against cover and in twilight conditions, pointing boldly to the intersection.

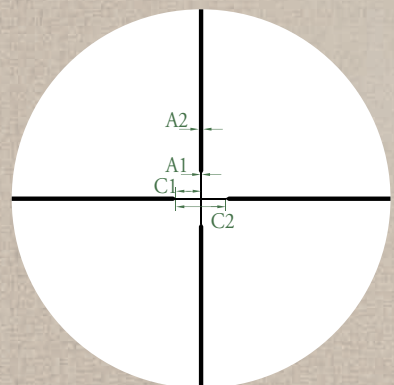

CENTER X

Mil Dot reticle is one of the most accurate, versatile means of estimating ranges using a manual optical device. The Mil Dot allows the user to do range estimations, holdover and wind drift compensation as well as for precise leads for moving targets.

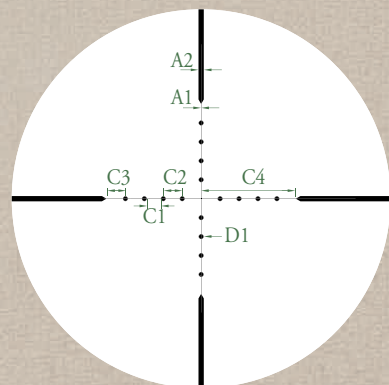

MILDOT

ATMR1 SFP IR MIL reticle is perfect for shooting at the range or competing in a competitions. The customized Mil hash mark design helps to eliminate any guesswork with holdover and windage adjustments. The illuminated reticle is great for low light situations when you need to count on a good, accurate shot.

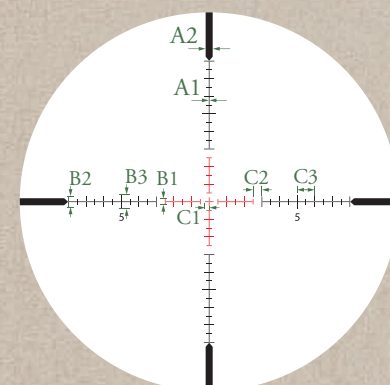

ATMR1 SFP IR MIL

BDC 600 IR was designed to deliver a high level of precision at extended targets that can be used with today's most popular rifle cartridges.

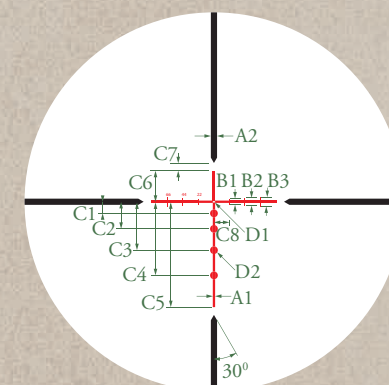

BDC 600 IR

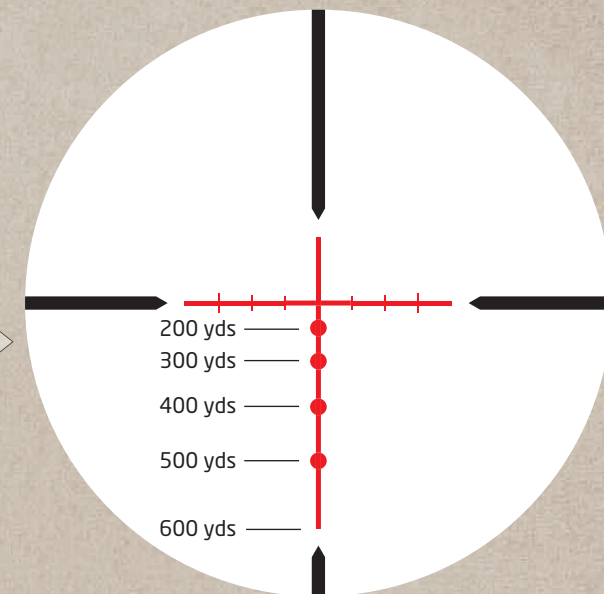

The **BDC 500 IR** will work with any of the following ammunition loads:

.223 Win 55 gr
.243 Win, 95 gr
25-06 Rem 115 gr
.270 Win, 130 gr
.270 WSM, 150 gr
.7mm Rem Mag, 150 gr
.7mm WSM, 150 gr
.30-06 Sprg, 150 gr
.300 Winchester Mag, 180 gr
300 WSM, 180 gr
.338 Win, 200 gr

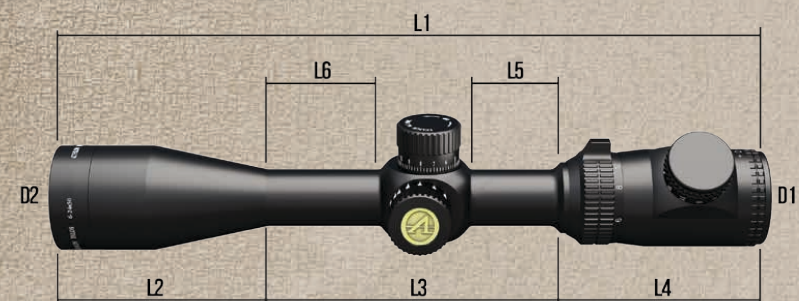

RIFLESCOPE DIMENSIONS

RIFLESCOPE MODEL	L1	L2	L3	L4	L5	L6	D1	D2
3-12x40 SFP	12	3.58	4.80	3.66	1.85	1.26	1.77	1.85
4-16x40 SFP	12.9	3.48	5.83	3.72	1.85	2.20	1.77	1.85
6-24x50 SFP	13.9	4.06	6.26	3.70	1.85	2.68	1.77	2.24

RETICLE SUBTENSIONS

CENTER X	A1	A2	C1	C2	CONFIGURATION										
SUBTENSIONS IN MOA	.18	.7	4.5	9	3-12x40										
MILDOT	A1	A2	C1	C2	C3	C4	D1								
SUBTENSIONS IN MOA	.05	.25	.75	1	1	5	.25								
BDC 600 IR	A1	A2	B1	B2	B3	C1	C2	C3	C4	C5	C6	C7	C8	D1	D2
SUBTENSIONS IN MOA	.3	.8	.8	1	1.2	1.5	3.5	6.25	9.5	13.6	4	1	2	0.2	1
ATMR1 SFP IR MIL	A1	A2	B1	B2	B3	C1	C2	C3							
SUBTENSIONS IN MIL	.02	.5	.3	.6	.8	.25	.5	1							

RIFLESCOPE DETAILED SPECS

POWER X OBJECTIVE LENS	TURRET STYLE	TUBE SIZE	AVAILABLE RETICLES	SURFACE FINISH	EYE RELIEF	FOV @100 YARDS	WEIGHT	LENGTH	CLICK VALUE	ADJ. RANGE PER ROTATION	TOTAL ELEV. ADJ.	TOTAL WINDAGE ADJ.	PARALLAX ADJ.	PURGING MATERIAL
3-12X40 SFP	CAPPED	1"	CENTER X	MATTE	3.82-3.35"	34.1-8.9 ft	16.2oz	12"	0.25 MOA	15 MOA	60 MOA	60 MOA	SIDE FOCUS 10yds - ∞	NITROGEN
			MILDOT											
			BDC 600 IR											
4-16X40 SFP	CAPPED	1"	MILDOT	MATTE	3.8-3.35"	24.1-6.28 ft	19.1 oz	12.9"	0.25 MOA	15 MOA	60 MOA	60 MOA	SIDE FOCUS 15yds - ∞	NITROGEN
			BDC 600 IR											
6-24X50 SFP	CAPPED	1"	BDC 600 IR	MATTE	3.11-3.03"	16.76-4.45 ft	23 oz	13.9"	0.25 MOA	15 MOA	50 MOA	50 MOA	SIDE FOCUS 10yds - ∞	NITROGEN
			ATMR1 SFP IR MIL						0.1 MIL	5 MIL	18 MIL	18 MIL		

* Reticle subtensions valid @12x, 16x,18x

** dimensions are given in inches

TECHNICAL INFORMATION

NEOS RIFLESCOPE

The Neos family is the perfect scope for those who want quality and lots of features, all while staying on a budget. Fully multicoated optics protected in a heat treated one piece aluminum tube, nitrogen purged to give you a waterproof, fog proof and shockproof scope. Rugged, precise, dependable, reliable, need we say more.....

Center X Reticle is a perfect choice for shooters wishing to have a clear field of view with a more traditional crosshair. The Center X reticle allows shooters to quickly view their target while maintaining one distinct aiming point on their reticle. The heavy posts stand out nicely against cover and in twilight conditions, pointing boldly to the intersection.

BDC22 Rim Fire Reticle was designed specifically for rimfire. This reticle allows shooters to compensate for bullet drop at extended shooting distances. When using a .22 LR with a muzzle velocity of approximately 1,600 feet per second, this reticle is designed to be zeroed at 50 yards, providing bullet drop compensation for 75, 100, 125 and 150 yards.

BDC 500 IR was designed to deliver a high level of precision at extended targets that can be used with today's most popular rifle cartridges.

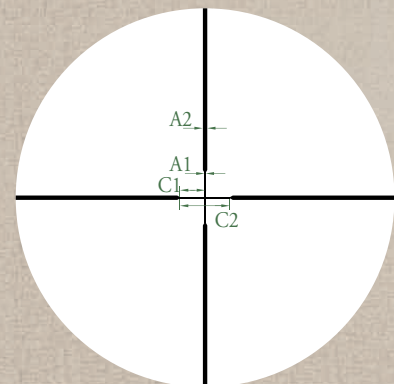
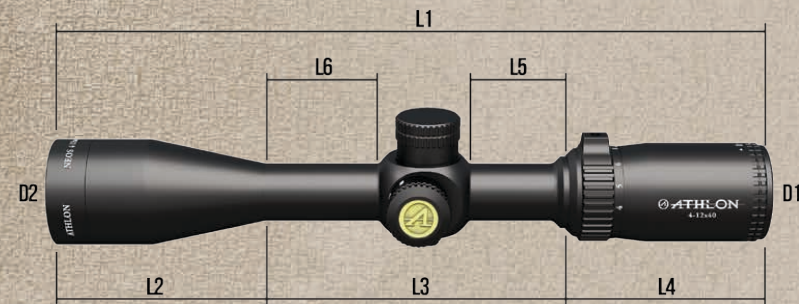

CENTER X

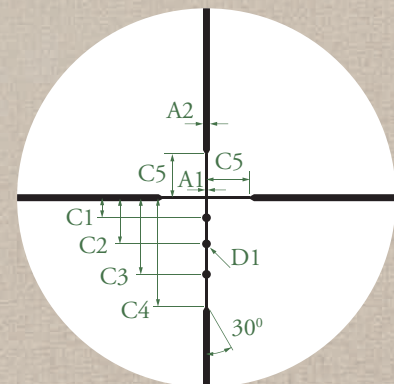

BDC 22 RIMFIRE

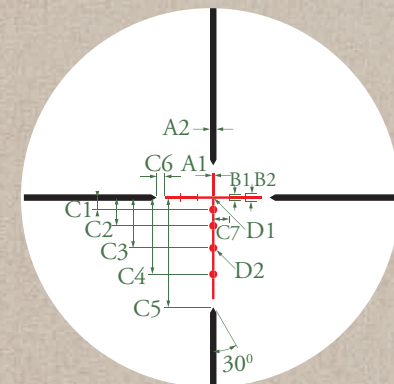

BDC 500 IR

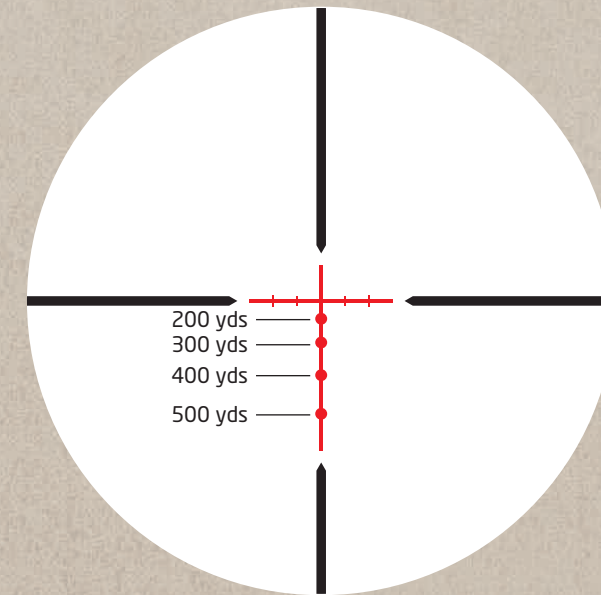

The **BDC 500 IR** will work with any of the following ammunition loads:

.223 Win 55 gr
.243 Win, 95 gr
25-06 Rem 115 gr
.270 Win, 130 gr
.270 WSM, 150 gr
.7mm Rem Mag, 150 gr
.7mm WSM, 150 gr
.30-06 Sprg, 150 gr
.300 Winchester Mag, 180 gr
300 WSM, 180 gr
.338 Win, 200 gr

Neos rifle scope internal dials:



RIFLESCOPE DIMENSIONS

RIFLESCOPE MODEL	L1	L2	L3	L4	L5	L6	D1	D2
3-9x40 SFP	12.5	3.25	5.75	3.5	2.25	2.25	1.62	1.88
4-12X40 SFP	12.5	3.25	5.75	3.5	2.25	2.25	1.62	1.88
6-18X44 SFP	13.5	3.75	6.25	3.5	2.25	3	1.62	2

RETICLE SUBTENSIONS

CENTER X	A1	A2	C1	C2	CONFIGURATION
SUBTENSIONS IN MOA	.25	.9	6.5	13	3-9x40
	.18	.7	4.5	9	4-12x40
	.12	.5	3.2	6.5	6-18x44

BDC 22 RIMFIRE	A1	A2	C1	C2	C3	C4	C5	D1
SUBTENSIONS IN MOA	.25	.8	2.3	5.3	8.8	12.5	5	1

BDC 500 IR	A1	A2	B1	B2	C1	C2	C3	C4	C5	C6	C7	D1	D2
SUBTENSIONS IN MOA	.3	.8	.8	1	1.5	3.5	6.25	9.5	13.6	1	2	.2	1

RIFLESCOPE DETAILED SPECS

POWER X OBJECTIVE LENS	TURRET STYLE	TUBE SIZE	AVAILABLE RETICLES	SURFACE FINISH	EYE RELIEF	FOV@100 YARDS	WEIGHT	LENGTH	CLICK VALUE	ADJ. RANGE PER ROTATION	TOTAL ELEV. ADJ.	TOTAL WINDAGE ADJ.	PARALLAX ADJ.	PURGING MATERIAL
3-9X40 SFP	CAPPED	1"	CENTER X	MATTE	2.99-3.07"	37.75-12.57 ft	16.1 oz	12.5"	0.25 MOA	15 MOA	80 MOA	80 MOA	FIXED 100 yds	NITROGEN
			BDC 500 IR											
			BDC 22 RIMFIRE											
4-12X40 SFP	CAPPED	1"	CENTER X	MATTE	3.39-3.19"	17.49-5.86 ft	16.1 oz	12.5"	0.25 MOA	15 MOA	50 MOA	50 MOA	SIDE FOCUS 10yds - ∞	NITROGEN
			BDC 500 IR											
6-18X44 SFP	CAPPED	1"	CENTER X	MATTE	3.39-3.19"	17.49-5.86 ft	16.5 oz	13.5"	0.25 MOA	15 MOA	50 MOA	50 MOA	SIDE FOCUS 10yds - ∞	NITROGEN
			BDC 500 IR											

* Reticle subtensions valid @9x, 12x, 18x

** dimensions are given in inches



**YOUR
ULTIMATE
PRIZE!**

14308 W 96TH TERRACE LENEXA, KS 66215

CONTACT@ATHLNOPTICS.COM  TOLL FREE: 1-855-913-5678 