

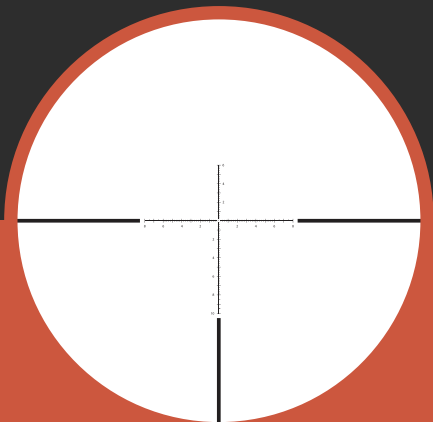

APRS2A SFP MIL

Talos BTR GEN2 Riflescope

SECOND FOCAL PLANE



RETICLE MANUAL

THE ATHLON® APRS2A SFP MIL RETICLE

APRS2A SFP MIL reticle is designed for precision rifle series competition and any other long range shooting applications with accurate ranging capability. It can help you quickly determine distance, hold-over positions and windage corrections. The unique design of fine .2 mil hash mark increments from center to 6 mils to both left and right helps the shooter set a quick windage holdover position after he or she dialed in elevation on their targets. The floating 0.09 center dot draws a shooter's vision right on target enabling him or her to engage a target at a blink of an eye.

Application: Precision Mid Range Shooting for both Tactical and Hunting

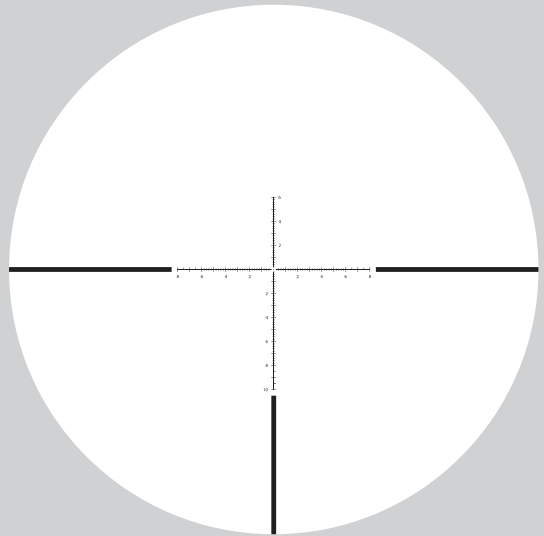

Reticle subtensions are valid @ 10x

RETICLE SUBTENSIONS

The APRS2A SFP MIL reticle is based on the milliradian, usually shortened to mrad or mil. A "mil" is defined as "one thousandth", or 1/1000. A mil is 1/1000 of a radian (a unit of angular measurement). Since there are 6.2832 radians in a circle, and each radian is chopped up into a thousand pieces, there are $6.2832 \times 1000 = 6,283.2$ mils in a circle. Since there are 360 degree in a circle, we can get $360 \text{ degree} / 6,283.2 \text{ mils} = 0.573 \text{ degree/mil}$. If the target is 100 yards (3600 inches) away, we can use $3600 \times \tan(\text{Radians}(0.573 \text{ degree}))$ to get 3.6 inches which means 1mil equals to 3.6 inches at 100 yards.

The APRS2A SFP MIL reticle is located at the second plane which stays in between erector tube and ocular lens. The size or the appearance of a second focal plane reticle does not change when you try to zoom in or zoom out, however the relative ratio between reticle and your target changes all the time because your target appears bigger or smaller when the magnification changes.

The subtensions of a second focal plain reticle and ranging capability are only accurate at certain magnification and due to this nature, the subtensions of the reticle are valid at 10x for 10x42 scope.

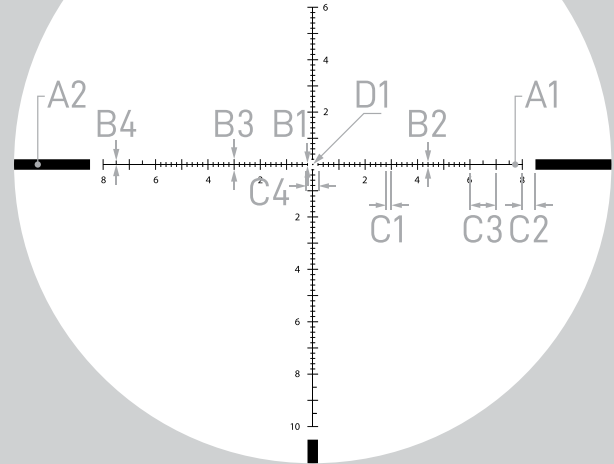

SUBTENSIONS IN MIL

A1	A2	B1	B2	B3	B4
0.04	0.4	0.1	0.18	0.4	0.15
C1	C2	C3	C4	D1	
0.2	0.5	1	0.4	0.09	

DISTANCE RANGING

Equations for ranging distance to a target using mils:

$$\frac{\text{Height of Target (Yards)} \times 1000}{\text{MIL Reading on Reticle}} = \text{Distance to Target (Yards)}$$

$$\frac{\text{Height of Target (Meters)} \times 1000}{\text{MIL Reading on Reticle}} = \text{Distance to Target (Meters)}$$

$$\frac{\text{Height of Target (Inches)} \times 27.8}{\text{MIL Reading on Reticle}} = \text{Distance to Target (Yards)}$$

Because the actual or at least closest estimate of the height of your target is the key part of above equations, you have to know the height of your target or heights of other objects nearby your target that are known to you.

As you can see the actual reading of your target is another key variable in those equations, you want to put your rifle on a steady rest as much as possible so you could get an accurate reading. If needed using the smallest measurement on the reticle to get the most accurate readings.

EXAMPLE

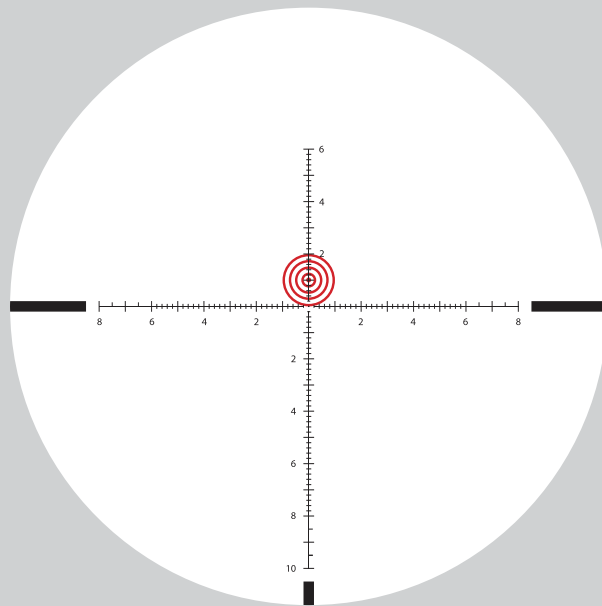

Reading a 3-foot target (1 yard) at 2 mils gives 500 yards

$$\frac{1 \text{ yard} \times 1000}{2 \text{ mils}} = 500 \text{ yards}$$

HOLDOVER FOR COMPENSATING BULLET DROP

To be able to use the elevation holdovers effectively, you have to know the distance to your target and bullet trajectory (bullet drop in inches or mils). Since most of bullet ballistic charts highlight bullet drops in inches, you have to know that, 1 mil equals to 3.6 inches at 100 yards, 7.2 inches at 200 yards, and 36 inches at 1000 yards, etc.

For example, under no wind condition, if you knew your target is at 500 yards and your ammo has a 54 inch bullet drop at that distance, you want to use 3 mil holdover point. Here is how you got the 3 mil: since 1 mil equals to 3.6 inches $\times 5 = 18$ inches at 500 yards, and then 3 mils equal to 3×18 inches = 54 inches at 500 yards, you want to hold the 3 mil drop point to compensate the 54 inch bullet drop.

To achieve ultimate precision, it is always a better idea to develop your own D.O.P.E (Data of Previous Engagement) chart so that you can refer back to it for specific bullet drop compensation under different ambient environment and weather condition.

EXAMPLE

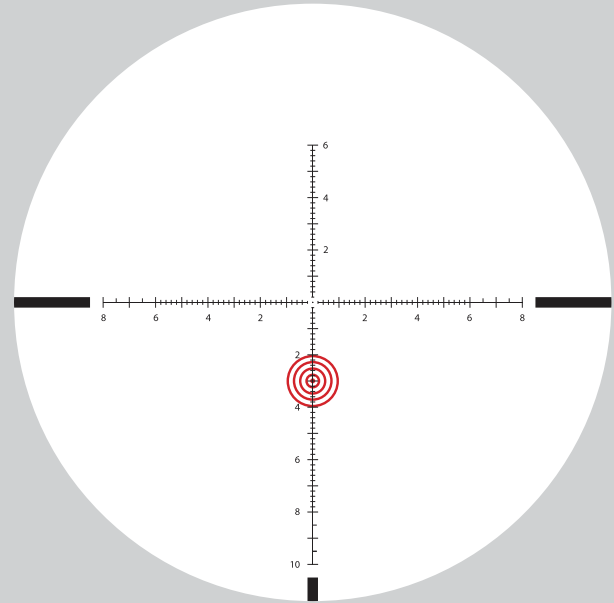

3 mil /54 inch holdover for a target @ 500 yards out. No wind.

HOLDOVER FOR WIND CORRECTION AND MOVING TARGET

The APRS2A SFP MIL reticle offers 8 mil span in hash marks from center to left and right, up and down. The APRS2A SFP MIL reticle provides great visual reference to allow you to spot your target in no time.

The flying time of a bullet, the velocity and direction of the wind and the "slippery-ness" of the bullet expressed in BC (Ballistic Coefficient) determine your holdover for wind correction. Once again you have to understand the impact of those three factors on your bullet's flying path in terms of inches or mils and calculate how much holdover you have to hold, and then finding the corresponding holdover position on the reticle is a much easier task to accomplish.

EXAMPLE

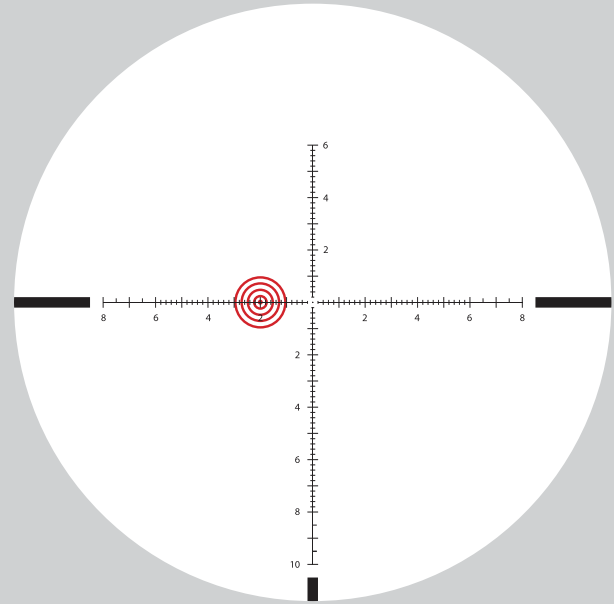

2 mil wind correction for 15 mph wind from right to left at 500 yards. Elevation turret has been dialed up to compensate bullet drop, just simply use center horizontal cross line to holdover for wind correction.

USE VISUAL CROSS POINT FOR WIND CORRECTION AND BULLET DROP

As an alternative, you can use a virtual cross point formed by hash marks on both horizontal and vertical cross lines to holdover bullet drop and wind correction.

EXAMPLE

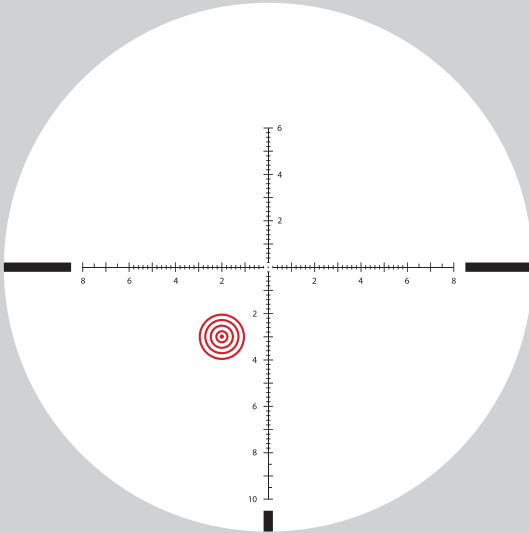

Use 3 mil to compensate a 54 inch bullet drop for a target at 500 yards, 2 mil wind correction for 15 mph wind from right to left.

HOLD LEAD CORRECTION FOR A MOVING TARGET

Distance to your target, moving speed of your target, bullet flying time, wind direction are the key factors that determine how much holdover you need to hold for a moving target. As a rule of thumb, you always hold the lead for the net distance of your target moved (add or subtract holdover for wind correction) during the time span your bullet traveled.

EXAMPLE

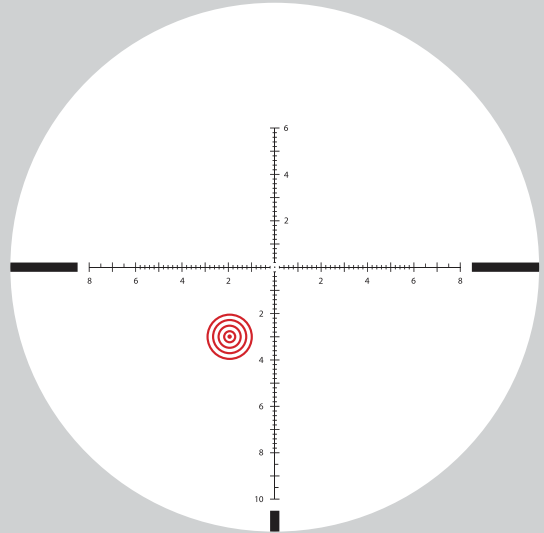

1.95 mil lead holdover for a moving target traveling at 2 mph from left to right at 500 yards. Bullet flight time is 1 second during which the target traveled 2.94 feet. No wind.

THE ATHLON GOLD MEDAL LIFETIME WARRANTY*

Demand the most from your equipment. When things go unexpectedly or accidents happen, rest assured, Athlon Optics carry a lifetime transferable warranty. Athlon guarantees to repair or replace your product if damaged through normal use. No charge; No receipt; No Registration required.

****This warranty does not cover damages caused by deliberate damage, misuse, theft or maintenance provided by someone other than the Athlon Authorized Service Department.***



**SHARP, TIGHT
AND PRICED
JUST RIGHT!**

Toll free: 1-855-913-5678

contact@athlonoptics.com

801 N MEADOWBROOK DR,
OLATHE, KS 66062

ATHLONOPTICS.COM