

ATHLON
RIDICULOUSLY GOOD OPTICS

ATMR3 FFP IR MIL

Ares ETR GEN2 UHD 1-10x24 Riflescope

FIRST FOCAL PLANE

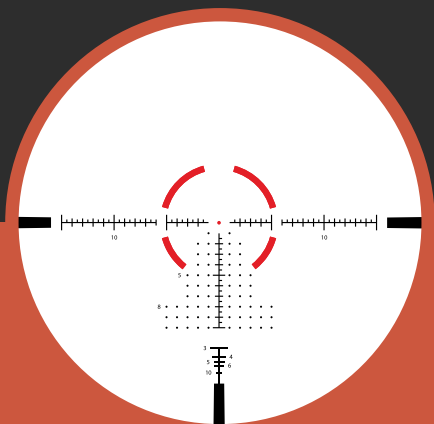

RETICLE MANUAL

THE ATHLON® ATMR3 FFP IR MIL RETICLE

ATMR3 FFP IR MIL reticle is the most versatile reticle for fast CQB or long-range engagements. The illuminated 10 mil quartered ring and precise .35 mil center aid in fast acquisition on low magnification. As the magnification increases the versatile holdover and windage subtensions become visible, turning this into a mid to long range capable optic. If mil ranging isn't for you, default to the simple silhouette target ranging tree at just above the vertical post.

Application: Short and Mid Range Shooting for both Tactical and Hunting

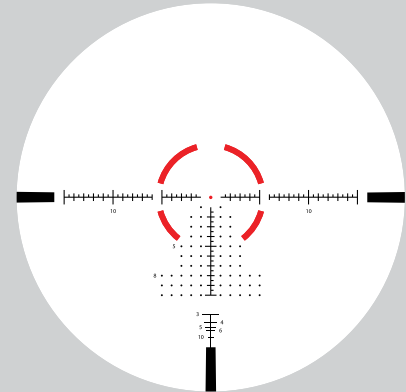
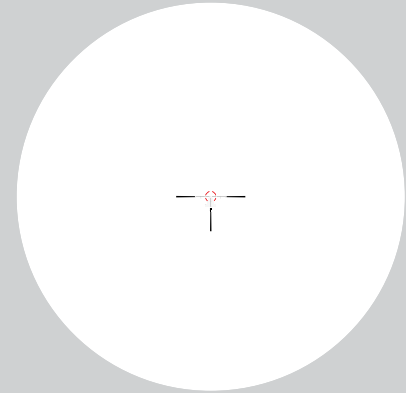

Note: The reticle image shown above will appear differently among different models due to different magnification and location of the reticle.

RETICLE SUBTENSIONS

The ATMR3 FFP IR MIL reticle is based on the milliradian, usually shortened to mrad or mil. A "mil" is defined as "one thousandth", or 1/1000. A mil is 1/1000 of a radian (a unit of angular measurement). Since there are 6.2832 radians in a circle, and each radian is chopped up into a thousand pieces, there are $6.2832 \times 1000 = 6,283.2$ mils in a circle. Since there are 360 degree in a circle, we can get $360 \text{ degree} / 6,283.2 \text{ mils} = 0.0573 \text{ degree/mil}$. If the target is 100 yards (3600 inches) away, we can use $3600 \text{ Tan } (.0573 \text{ degree})$ to get 3.6 inches which means 1mil equals to 3.6 inches at 100 yards

The ATMR3 FFP IR MIL reticle is located at the focal plane in the front of the erector tube which is a key part of achieving variable power inside the riflescope. Size of the first focal plane reticle grows or shrinks at the same ratio with the changing size of the image of your target when you try to zoom in or zoom out. Since the size of the reticle remains constant compared to your target regardless of the magnification, the subtension of the reticle remains valid all the time. The reticle at 1x actually becomes a center dot for effectively engaging shorter range targets while at 10x it provides finer details for a shooter to locate proper hold over positions for longer range targets.

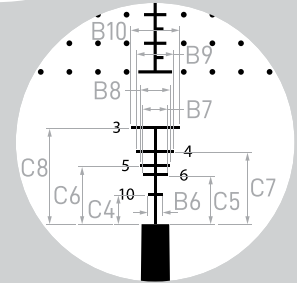
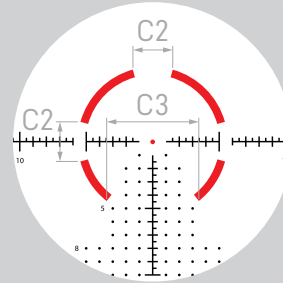
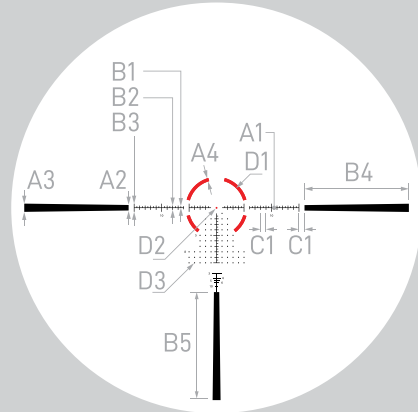

SUBTENSIONS IN MIL

A1	A2	A3	A4	B1	B2	B3	B4	B5	B6	B7	B8	B9
0.11	1	1.5	0.6	0.3	0.8	1.5	19	19.67	0.5	0.83	1	1.25
B10	C1	C2	C3	C4	C5	C6	C7	C8	D1	D2	D3	
1.67	1	3	7	1	1.67	2	2.5	3.33	10	0.35	0.15	

DISTANCE RANGING

Equations for ranging distance to a target using mils:

$$\frac{\text{Height of Target (Yards)} \times 1000}{\text{MIL Reading on Reticle}} = \text{Distance to Target (Yards)}$$

$$\frac{\text{Height of Target (Meters)} \times 1000}{\text{MIL Reading on Reticle}} = \text{Distance to Target (Meters)}$$

$$\frac{\text{Height of Target (Inches)} \times 27.8}{\text{MIL Reading on Reticle}} = \text{Distance to Target (Yards)}$$

Because the actual or at least closest estimate of the height of your target is the key part of above equations, you have to know the height of your target or heights of other objects nearby your target that are known to you.

As you can see the actual reading of your target is another key variable in those equations, you want to put your rifle on a steady rest as much as possible so you could get an accurate reading. If needed using the smallest measurement on the reticle to get the most accurate readings.

EXAMPLE

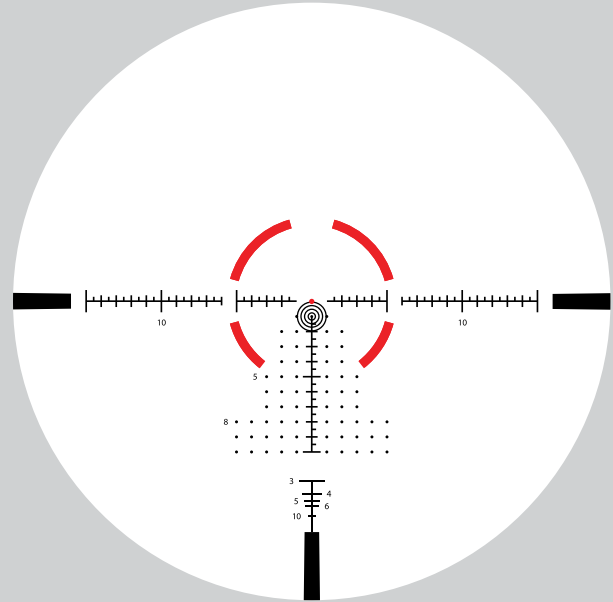

Reading a 3-foot target (1 yard) at 2 mils gives 500 yards

$$\frac{1 \text{ yard} \times 1000}{2 \text{ mils}} = 500 \text{ yards}$$

HOLDOVER FOR COMPENSATING BULLET DROP

To be able to use the elevation holdovers effectively, you have to know the distance to your target and bullet trajectory (bullet drop in inches or mils). Since most of bullet ballistic charts highlight bullet drops in inches, you have to know that, 1 mil equals to 3.6 inches at 100 yards, 7.2 inches at 200 yards, and 36 inches at 1000 yards, etc.

For example, under no wind condition, if you knew your target is at 500 yards and your ammo has a 54 inch bullet drop at that distance, you want to use 3 mil holdover point. Here is how you got the 3 mil: since 1 mil equals to 3.6 inches $\times 5 = 18$ inches at 500 yards, and then 3 mils equal to 3×18 inches = 54 inches at 500 yards, you want to hold the 3 mil drop point to compensate the 54 inch bullet drop.

To achieve ultimate precision, it is always a better idea to develop your own D.O.P.E (Data of Previous Engagement) chart so that you can refer back to it for specific bullet drop compensation under different ambient environment and weather condition.

EXAMPLE

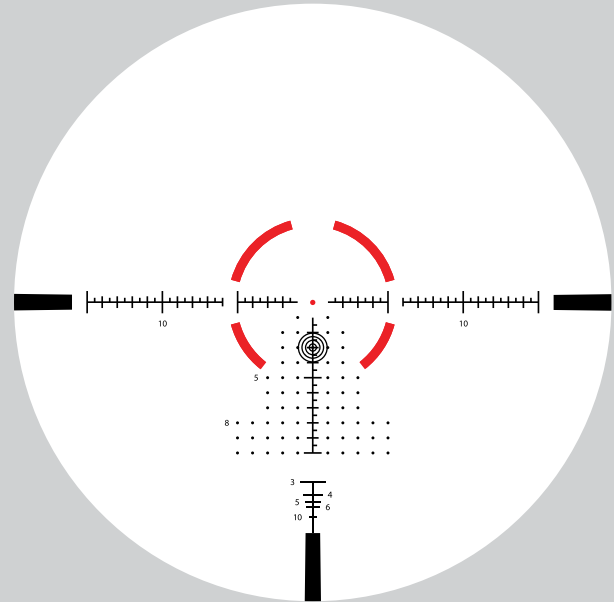

3 mil /54 inch holdover for a target @ 500 yards out. No wind.

HOLDOVER FOR WIND CORRECTION AND MOVING TARGET

The ATMR3 FFP IR MIL reticle, starting with a line of dots in 1 mil intervals and all the way down to 5 mils on each side at 10th mil drop line, the ATMR3 FFP IR MIL reticle provides great details of holdover positions to achieve higher level of precision and allows you to spot your holdovers for wind correction and moving targets in no time.

The flying time of a bullet, the velocity and direction of the wind and the "slippery-ness" of the bullet expressed in BC (Ballistic Coefficient) determine your holdover for wind correction. Once again you have to understand the impact of those three factors on your bullet's flying path in terms of inches or mils and calculate how much holdover you have to hold, and then finding the corresponding holdover position on the reticle is a much easier task to accomplish.

EXAMPLE

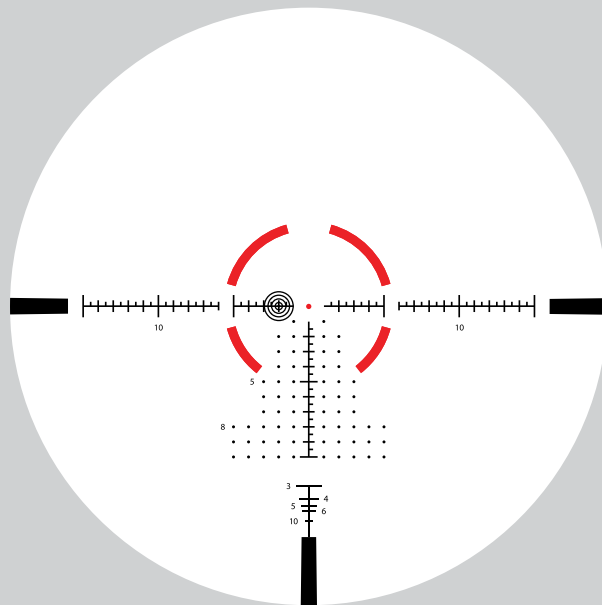

2 mil wind correction for 15 mph wind from right to left at 500 yards. Elevation turret has been dialed up to compensate bullet drop, just simply use center horizontal cross line to holdover for wind correction.

USE VISUAL CROSS POINT FOR WIND CORRECTION AND BULLET DROP

As an alternative, you can use a virtual cross point formed by hash marks on both horizontal and vertical cross lines to holdover bullet drop and wind correction.

EXAMPLE

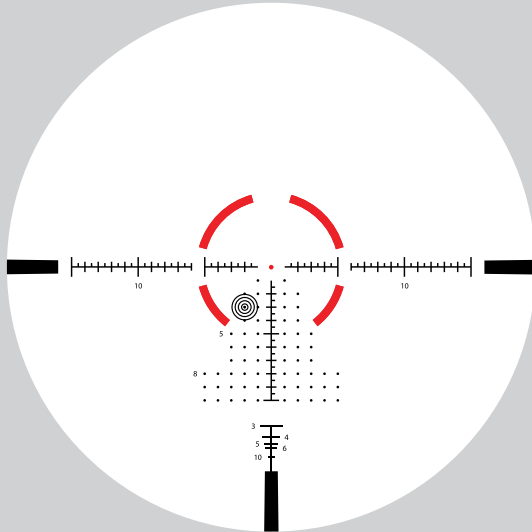

Use 3 mil to compensate a 54 inch bullet drop for a target at 500 yards, 2 mil wind correction for 15 mph wind from right to left.

HOLD LEAD CORRECTION FOR A MOVING TARGET

Distance to your target, moving speed of your target, bullet flying time, wind direction are the key factors that determine how much holdover you need to hold for a moving target. As a rule of thumb, you always hold the lead for the net distance of your target moved (add or subtract holdover for wind correction) during the time span your bullet traveled.

EXAMPLE

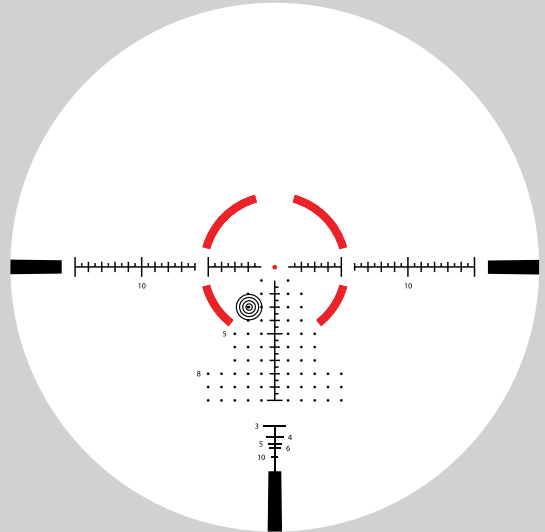

1.95 mil lead holdover for a moving target traveling at 2 mph from left to right at 500 yards. Bullet flight time is 1 second during which the target traveled 2.94 feet. No wind.

DISTANCE RANGING RETICLE

EXAMPLE

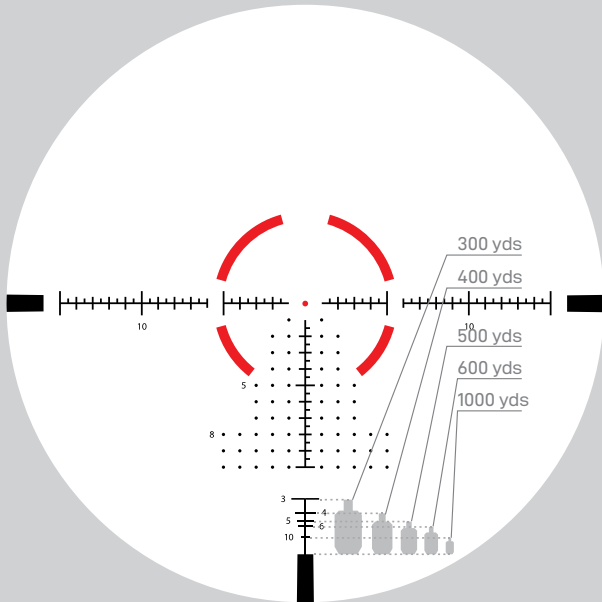

The gap between the ranging reticle line to the top of the thick black line is 36 inches, a height of a standard silhouette target.

DETAIL

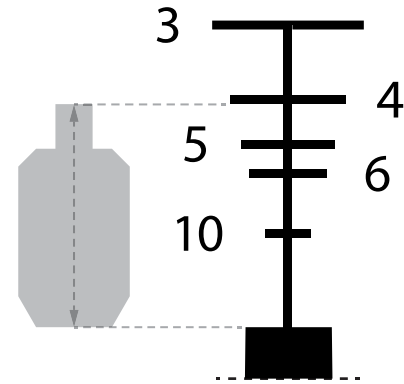

Example of a 36 inch silhouette target at 400 yds.

If you can fit a silhouette target into a gap just call out the distance in hundred yards by using the number beside the horizontal line.

THE ATHLON GOLD MEDAL LIFETIME WARRANTY*

Demand the most from your equipment. When things go unexpectedly or accidents happen, rest assured, Athlon Optics carry a lifetime transferable warranty. Athlon guarantees to repair or replace your product if damaged through normal use. No charge; No receipt; No Registration required.

****This warranty does not cover damages caused by deliberate damage, misuse, theft or maintenance provided by someone other than the Athlon Authorized Service Department.***



**SHARP, TIGHT
AND PRICED
JUST RIGHT!**

Toll free: 1-855-913-5678

contact@athlonoptics.com

10817 RENNER BLVD,
LENEXA, KS 66219

ATHLONOPTICS.COM