



ATHLON

OPTICS

2017 PRODUCT CATALOG





ATHLON IS YOUR PRIZE IN OPTICS

ATHLON is a proud US sports optics product company devoted to designing and delivering superior quality optics products and outdoor accessories at a competitive price to our consumers via our distribution and retail channels. Athlon has strong engineering design capability, strategic alliances with quality manufacturers and a streamlined fully integrated supply chain. These advantages enable us to bring the latest cutting edge technologies and cut out the extra layers of traditional supply chain. With these

advantages we are able to deliver goods and products to individual consumers' hands with great cost savings.

Our obsession with product quality and superior customer service for hunters, recreational shooters, and outdoor enthusiasts drives our business. The business model on which we founded Athlon allows us to deliver high quality optics at extremely competitive prices. Our goal from day one is to pass those savings to you, the outdoor enthusiast.

ATHLON LIFETIME WARRANTY

Your Athlon product is not only warranted to be free of defects in materials and workmanship for the lifetime of the product. Athlon will also repair or replace the product at no charge to you if you damage it through normal use. No receipt needed, no registration required. This is a commitment that Athlon Optics will be the best product you can buy for your money. This warranty does not cover damages caused by deliberate damage, misuse, theft or maintenance provided by someone other than the Athlon Authorized Service Department.



CONTENT

BINOCULARS

- 4-5 **CRONUS**
10x42, 8.5x42
- 6-7 **ARES**
10x42, 8x42, 10x36, 8x36
- 8 **MIDAS**
12x50, 10x50, 10x42, 8x42
- 9 **ARGOS**
12x50, 10x50, 10x42, 8x42, 10x34, 8x34
- 10 **TALOS**
12x50, 10x50, 10x42, 8x42, 10x32, 8x32
- 11 **NEOS**
12x50, 10x50, 10x42, 8x42, 10x32, 8x32

RIFLESCOPES

- 12-13 **CRONUS^{BTR}**
4.5-29x56
- 14-15 **CRONUS**
1-6x24, 4.5-29x56
- 16-17 **ARES^{BTR}**
2.5-15x50, 4.5-27x50
- 18-19 **MIDAS^{BTR}**
1-6x24, 2.5-15x50, 4.5-27x50
- 20-21 **HELOS^{BTR}**
6-24x50, 8-34x56
- 22-23 **ARGOS^{BTR}**
1-4x24, 6-24x50, 8-34x56
- 24-25 **ARGOS**
2-10x40, 3-15x40, 4-20x50, 6-30x56
- 26 **TALOS^{BTR}**
1-4x24, 4-14x44
- 27 **TALOS**
3-12x40, 4-16x40, 6-24x50
- 28-29 **NEOS**
3-9x40, 4-12x40, 6-18x44

SPOTTING SCOPES

- 30-31 **CRONUS**
20-60x86 ED, 12-36x50 ED
- 32-33 **ARES**
20-60x85 ED, 15-45x65 ED, 7.5-22.5x50 ED

RED DOTS

- 34-35 **MIDAS^{BTR} RED DOT SIGHTS**
RD11, RD12, RD13
- 36-37 **MIDAS^{BTR} PRISM SCOPES**
PR11, PR31, PR41
- 38-39 **MIDAS^{BTR} MAGNIFIERS**
MG31, MG51

LASER RANGEFINDERS

- 40-41 **MIDAS 1200Y**

ACCESSORIES

- 42-43 Binocular Harness, Binocular Tripod Adapter, Scope Sunshade

TECHNICAL INFORMATION

- 44-47 **CRONUS^{BTR} RIFLESCOPES**
- 48-49 **CRONUS RIFLESCOPES**
- 50-51 **ARES^{BTR} RIFLESCOPES**
- 52-53 **MIDAS^{BTR} RIFLESCOPES**
- 54-55 **HELOS^{BTR} RIFLESCOPES**
- 56-59 **ARGOS^{BTR} RIFLESCOPES**
- 60-61 **ARGOS RIFLESCOPES**
- 62-63 **TALOS^{BTR} RIFLESCOPES**
- 64-65 **TALOS RIFLESCOPES**
- 66-67 **NEOS RIFLESCOPES**
- 68 **MIDAS^{BTR} RED DOT SIGHTS**
- 69 **MIDAS^{BTR} PRISM SCOPES**

KEY PRODUCT FEATURES



Apochromatic lens system gives you the result of images which have greater contrast, sharpness and color definition.



ESP Dielectric Coating is a multi layer prism coating that reflects over 99% of the light to your eyes bringing you a clear, bright image that displays accurate color reproduction.



Argon purging gives you better waterproofing and thermal stability



Bak-4 glass prisms reflect more light to your eyes thus will give you brighter and sharper image.



ED glass gives you an image with little or no chromatic fringe for a clearer and sharper image



Waterproof to protect the binocular in the harshest weather conditions or if accidentally submerged underwater.



Precision Zero Stop System allows you to return to your zero position and dial back to it with a sharp and precise stop right at your zero location



Locking Turrets allow you to pull up your turret to dial, and push down the turret to lock it in place.



HD Glass gives you the utmost contrast, color reproduction, and the sharpest image.



Advanced Fully Multi-Coated lenses deliver the highest level of light transmission for maximum brightness and true color across the entire light spectrum.



EZES System is a field flattening system that produces sharper, clearer images all the way from one lens edge to another



Phase corrected prisms produce images that have better contrast, a higher resolution and excellent color reproduction.



XPL Coating gives you an extra protection on the exterior lenses from dirt, oil and scratches



Fully Multi-Coated lenses bring you better light transmission to bring optimum brightness and true color across the entire light spectrum.



Multicoated optics effectively reduce reflected light and increase the transmission of light giving you a brighter image than normal single coated lenses



Magnesium chassis give you the strength of a metal chassis while reducing the weight as much as 35%



BINOCULARS CRONUS

Just like its namesake, Cronus the King of all the Mythological Greek Titans, this is the top of the Athlon Optics products. Athlon brings to you in the Cronus family, products inspired by a combined commitment to brightness, clarity and resolution.

Designed for serious glassing, with exceptional edge to edge clarity, sharp detail enhancement, ultra-clear brightness and true color representation. Whether you are on your annual hunt for whitetails on the family farm in Alabama or filling your tag on an once in a lifetime Montana Big Horn, don't leave anything to chance. We designed these binoculars with our revolutionary E2ES lens system that gives you a flat field of view. We included ED Glass that results in clearer and sharper image to your eyes.

Our state of the art ESP (Enhance Spectral Prism) dielectric coating that reflects 99% of the light through the prism assembly. We use a Magnesium chassis to reduce weight while keeping the chassis rugged to withstand the scrapes and bumps of constant use.



"COMBINED COMMITMENT TO BRIGHTNESS, CLARITY AND RESOLUTION"



ATHLON
OPTICS

CRONUS SPECIFICATION

	OBJ. LENS DIA.	EYE RELIEF	FIELD OF VIEW ANGULAR	FOV @1000 YARDS	CLOSE FOCUS	INTERPILLARY DIST.	WEIGHT	HEIGHT X WIDTH
10x42	42 mm	19.3 mm	6.5°	338 ft	6.6 ft	56-73 mm	33 oz	6.3x5.1"
8.5x42	42 mm	22 mm	7.6°	399 ft	6.6 ft	56-73 mm	33 oz	6.3x5.1"



Argon purging gives you better waterproofing and thermal stability



ED glass gives you an image with little or no chromatic fringe for a clearer and sharper image



E2ES System is a field flattening system that produces sharper, clearer images all the way from one lens edge to another



XPL Coating gives you an extra protection on the exterior lenses from dirt, oil and scratches



ESP Dielectric Coating is a multi layer prism coating that reflects over 99% of the light to your eyes bringing you a clear, bright image that displays accurate color reproduction.



Phase corrected prisms produce images that have better contrast, a higher resolution and excellent color reproduction.



Bak-4 glass prisms reflect more light to your eyes thus will give you brighter and sharper image.



Advanced Fully Multi-Coated lenses deliver the highest level of light transmission for maximum brightness and true color across the entire light spectrum.



Waterproof to protect the binocular in the harshest weather conditions or if accidentally submerged underwater.

OTHER FEATURES: Magnesium chassis, Locking diopter, Long eye relief, Close focus, Twist up eye-cups



ARES SPECIFICATION

	OBJ. LENS DIA.	EYE RELIEF	FIELD OF VIEW ANGULAR	FOV @1000 Yards	CLOSE FOCUS	INTERPUPILLARY DIST	WEIGHT	HEIGHT X WIDTH
10x42	42 mm	14.7 mm	6.5°	341 ft	8.2 ft	56-73 mm	29.8 oz	6.7x5.2"
8x42	42 mm	16.5 mm	6.5°	426 ft	6.5 ft	56-73 mm	29.8 oz	6.7x5.2"
10x36	36 mm	13.9 mm	6.17°	351 ft	8.2 ft	56-74 mm	24.9 oz	6.1x4.9"
8x36	36 mm	14.9 mm	7.17°	405 ft	6.5 ft	56-74 mm	24.9 oz	6.1x4.9"

BINOCULARS ARES

Ares lightweight open-bridge design is an example of the new innovative thinking that went into the unique design. Put in a few words, Ares optics are first-class.

They have ED glass lenses with Advance multi-coated and feature BaK4 prisms with the new ESP Dielectric Coating and Phase Coating. They bring super-premium clarity and brightness within the reach of most avid enthusiasts Their tough Magnesium chassis is fog proof and waterproof and filled with Argon to give you better internal fog proofing and thermal stability. They are covered with a durable rubber armor.

Bottom line? Just like Ares the Greek god of war, they will stand up to a punishment. They're the perfect combination of lightweight construction, optical quality and rugged durability.



10 X 42MM / 8 X 42MM



10 X 36MM / 8 X 36MM

ATHLON OPTICS



Argon purging gives you better waterproofing and thermal stability



ED glass gives you an image with little or no chromatic fringe for a clearer and sharper image



XPL Coating gives you an extra protection on the exterior lenses from dirt, oil and scratches



ESP Dielectric Coating is a multi layer prism coating that reflects over 99% of the light to your eyes bringing you a clear, bright image that displays accurate color reproduction.



Phase corrected prisms produce images that have better contrast, a higher resolution and excellent color reproduction.



BaK-4 glass prisms reflect more light to your eyes thus will give you brighter and sharper image.



Advanced Fully Multi-Coated lenses deliver the highest level of light transmission for maximum brightness and true color across the entire light spectrum.



Waterproof to protect the binocular in the harshest weather conditions or if accidentally submerged underwater.



Magnesium chassis give you the strength of a metal chassis while reducing the weight as much as 35%

OTHER FEATURES: Locking diopter, Long eye relief, Close focus, Twist up eye-cups



BINOCULARS MIDAS

Midas was known to have a golden touch. He must have laid his hands on these binoculars since they set the gold standard for this class of binoculars. The rugged benchmark for all-weather brightness and clarity, Midas roof-prism binoculars are light and slim thanks to a magnesium chassis. With their ED Glass lenses, Advanced Fully Multi-Coated optics, high-quality Bak-4 prisms with our ESP Dielectric coating plus phase coating, the Midas binos gather maximum light and produce brilliant color fidelity.



12 X 50MM / 10 X 50MM



10 X 42MM / 8 X 42MM



MIDAS SPECIFICATION

	OBJ. LENS DIA.	EYE RELIEF	FIELD OF VIEW ANGULAR	FOV @1000 YARDS	CLOSE FOCUS	INTERPILLARY DIST.	WEIGHT	HEIGHT X WIDTH
12x50	50 mm	15 mm	5.4 °	281 ft	11.48 ft	59-74 mm	33 oz	6.7x5.4"
10x50	50 mm	16.9 mm	6.5 °	341 ft	9.84 ft	59-74 mm	33 oz	6.7x5.4"
10x42	42 mm	15.2 mm	6.5 °	341 ft	8.2 ft	57-74 mm	25 oz	5.7x5.2"
8x42	42 mm	17.2 mm	8.1 °	426 ft	6.5 ft	57-74 mm	25 oz	5.7x5.2"



Argon purging gives you better waterproofing and thermal stability



Phase corrected prisms produce images that have better contrast, a higher resolution and excellent color reproduction.



ED glass gives you an image with little or no chromatic fringe for a clearer and sharper image



XPL Coating gives you an extra protection on the exterior lenses from dirt, oil and scratches

OTHER FEATURES: Magnesium chassis, ESP Dielectric Coating, Bak-4 glass prisms, Advanced Fully Multi-Coated lenses, Long eye relief, Close focus, Twist up eye-cups, Waterproof



Argon purging gives you better waterproofing and thermal stability



Phase corrected prisms produce images that have better contrast, a higher resolution and excellent color reproduction.



ESP Dielectric Coating is a multi layer prism coating that reflects over 99% of the light to your eyes bringing you a clear, bright image that displays accurate color reproduction.



XPL Coating gives you an extra protection on the exterior lenses from dirt, oil and scratches

OTHER FEATURES: Bak-4 glass prisms, Advanced Fully Multi-Coated lenses, Long eye relief, Close focus, Twist up eye-cups, Waterproof

ARGOS SPECIFICATION

OBJ. LENS DIA.	EYE RELIEF	FIELD OF VIEW ANGULAR	FOV @1000 YARDS	CLOSE FOCUS	INTERPILLARY DIST.	WEIGHT	HEIGHT X WIDTH
50 mm	16 mm	4.9 °	257 ft	13 ft	56-76 mm	29.5 oz	6.8x5.6" 12x50
50 mm	17 mm	5.8 °	304 ft	13 ft	56-76 mm	29.5 oz	6.8x5.6" 10x50
42 mm	16.1 mm	6.1 °	319 ft	13 ft	56-76 mm	24.6 oz	5.7x5.3" 10x42
42 mm	17.3 mm	7.1 °	371 ft	13 ft	56-76 mm	24.6 oz	5.7x5.3" 8x42
34 mm	16 mm	6.0 °	314 ft	13 ft	56-76 mm	16.3 oz	5.1x4.9" 10x34
34 mm	17.4 mm	7.1 °	371 ft	13 ft	56-76 mm	16.3 oz	5.1x4.9" 8x34



12 X 50MM / 10 X 50MM



10 X 42MM / 8 X 42MM



10 X 34MM / 8 X 34MM

BINOCULARS ARGOS

The Argos has an open-bridge style some hunters prefer for its secure ergonomic one-handed grip and comfortable in any weather condition. They come with superior quality and bright lenses that are Advanced fully multi-coated for sharp contrast, true color and excellent light gathering. They also have Bak-4 prism glass that have our new ESP Dielectric coating and phase correction for color fidelity and sharpness. They also have an Argon purged waterproof, non-fogging polymer composite chassis that takes weight off your neck but stands up to the demands of hunting.



ATHLON OPTICS



BINOCULARS TALOS

Whether you're hunting, hiking, fishing or adding species to your life list. The Talos binoculars are built tough, with a rubber-armor housing that's O-ring sealed and nitrogen purged for 100% waterproof/fog-proof dependability. They stretch available light with advanced fully multi-coated optics and premium BaK-4 prisms with phase coating deliver outstanding color fidelity and sharpness. A lightweight composite chassis and streamlined, roof-prism design make them comfortable to carry.



TALOS SPECIFICATION

OBJ. LENS DIA.	EYE RELIEF	FIELD OF VIEW ANGULAR	FOV @1000 YARDS	CLOSE FOCUS	INTERPUPILLARY DIST	WEIGHT	HEIGHT X WIDTH	
50 mm	18.2 mm	4.6 °	242 ft	11.48 ft	56-73 mm	29.8 oz	6.7x5.2"	12x50
50 mm	19.5 mm	5.4 °	284 ft	9.84 ft	56-73 mm	29.8 oz	6.7x5.2"	10x50
42 mm	15.2 mm	6.25 °	341 ft	8.2 ft	56-73 mm	25.5 oz	5.8x4.9"	10x42
42 mm	17.2 mm	8.16 °	394 ft	6.56 ft	56-73 mm	25.5 oz	5.8x4.9"	8x42
32 mm	14.8 mm	6.5 °	341 ft	9.84 ft	56-73 mm	19.3 oz	4.9x4.3"	10x32
32 mm	14.7 mm	8.1 °	427 ft	8.2 ft	56-73 mm	19.3 oz	4.9x4.3"	8x32



12 X 50MM / 10 X 50MM



10 X 42MM / 8 X 42MM



10 X 32MM / 8 X 32MM



BaK-4 glass prisms reflect more light to your eyes thus will give you brighter and sharper image.



Phase corrected prisms produce images that have better contrast, a higher resolution and excellent color reproduction.



Advanced Fully Multi-Coated lenses deliver the highest level of light transmission for maximum brightness and true color across the entire light spectrum.



Waterproof to protect the binocular in the harshest weather conditions or if accidentally submerged underwater.

OTHER FEATURES: Long eye relief, Close focus, Twist up eye-cups, Nitrogen purged



BaK-4 glass prisms reflect more light to your eyes thus will give you brighter and sharper image.



Multicoated optics effectively reduce reflected light and increase the transmission of light giving you a brighter image than normal single coated lenses



Waterproof to protect the binocular in the harshest weather conditions or if accidentally submerged underwater.

OTHER FEATURES: Long eye relief, Close focus, Twist up eye-cups, Nitrogen purged



BINOCULARS NEOS

We build optics to withstand the elements, no matter what class of binos they are in. If you spend any time outdoors you will be near water, and your equipment will spend some time in it. The Neos series binoculars are built tough, with a composite chassis that's O-ring sealed and nitrogen purged for 100% waterproof/fog-proof so if you simply run into foul weather along the way or should you take spill in a mountain stream, or for that matter take a spill overboard, your Neos binos are ready for it. Rubber armoring gives you a grip in slippery situations.



NEOS SPECIFICATION

OBJ. LENS DIA.	EYE RELIEF	FIELD OF VIEW ANGULAR	FOV @1000 YARDS	CLOSE FOCUS	INTERPUPILLARY DIST	WEIGHT	HEIGHT X WIDTH	
50 mm	14 mm	5.6 °	294 ft	23 ft	56-72 mm	33.5 oz	7.9x6.9"	12x50
50 mm	19 mm	6.5 °	342 ft	16.4 ft	56-72 mm	33.5 oz	7.9x6.9"	10x50
42 mm	14.1 mm	5.9 °	309 ft	13.1 ft	56-72 mm	24.8 oz	5.9x4.9"	10x42
42 mm	17 mm	7.0 °	367 ft	13.1 ft	56-72 mm	25.5 oz	5.9x4.9"	8x42
32 mm	17.2 mm	7.0 °	367 ft	9.8 ft	56-72 mm	19.4 oz	4.9x4.3"	10x32
32 mm	13.6 mm	7.5 °	393 ft	16.4 ft	56-72 mm	19.4 oz	4.9x4.3"	8x32



12 X 50MM / 10 X 50MM



10 X 42MM / 8 X 42MM



10 X 32MM / 8 X 32MM





First Focal Plane Reticles

RIFLESCOPES CRONUS^{BTR}

NEW

Whether you want to do precision long-range shooting and tactical applications, or extreme long range hunting adventures, the new Cronus BTR scope is just what the doctor ordered. With all of the same key features of the Cronus line, the new Cronus BTR is redesigned to be even better! We improved the parallax adjustment yard markings to go from 25 yards to infinity (added markings at 300, 500, 800 and 1600 yards), designed a new reticle as well as redesigned the battery compartment to make it easier to adjust the illumination. The best just got better!



4.5 - 29 X 56MM

AVAILABLE RETICLES

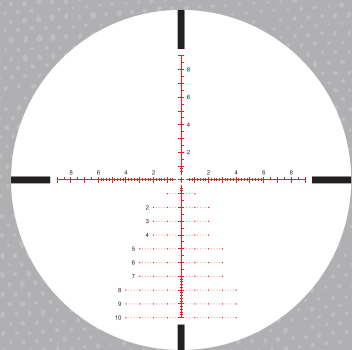

APRS FFP IR MIL

CRONUS^{BTR} SPECIFICATIONS

POWER X OBJECTIVE LENS	TURRET STYLE	TUBE SIZE	AVAILABLE RETICLES	EYE RELIEF	FOV @100 YARDS	WEIGHT	LENGTH
4.5-29x56 FFP	EXPOSED	34mm	APRS FFP IR MIL	3.6-3.8"	24.8-3.83 ft	35.8 oz	14.4"



HD Glass gives you the utmost contrast, color reproduction, and the sharpest image.



Advanced Fully Multi-Coated lenses deliver the highest level of light transmission for maximum brightness and true color across the entire light spectrum.



Argon purging gives you better waterproofing and thermal stability



XPL Coating gives you an extra protection on the exterior lenses from dirt, oil and scratches



Waterproof to protect the riflescope in the harshest weather conditions or if accidentally submerged underwater.



Precision Zero Stop System allows you to return to your zero position and dial back to it with a sharp and precise stop right at your zero location

First Focal Plane Reticle stays valid at all power settings allowing you to fully utilize the specially designed reticle that shrinks or grows along with your target as you zoom in or out. The reticle offers quick target engagement at low power while offering precise holdover positions with finer details.

High Precision Erector System processed by high precision CNC machine with +/- 0.0001mm tolerance level to provide you the most accurate power settings and smoothest magnification change

OTHER FEATURES: Side Parallax Adjustment, 6061 - T6 - 34mm Tubes, Illuminated Glass Reticles, Exposed Turrets



■ First Focal Plane Reticles
RIFLESCOPES
CRONUS

When compromise is not an option you need to make sure you have the best. That is a sufficient reason to own one of the best scopes you can get: The Cronus by Athlon. It is equipped with our advanced fully multi-coated lenses so you'll have the brightest, clearest image possible in any situation. The innovative new XPL coating protects your lenses from oil, dirt and smudges. This ultra-strong one-piece tube is hammer-forged from an aircraft aluminum alloy for more strength than standard aluminum, multi-piece scope tubes. The 6x magnification ratio eliminates the need for multiple scopes for different game or types of hunting.



1 - 6 X 24MM (MIL)



1 - 6 X 24MM (MOA)



4.5 - 29 X 56MM

AVAILABLE RETICLES

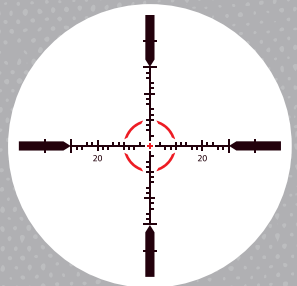

ATSR16 FFP IR-MOA

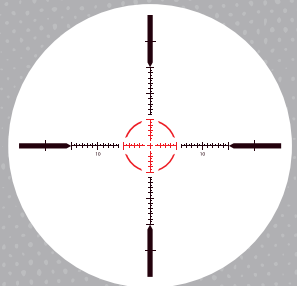

ATSR16 FFP IR-MIL

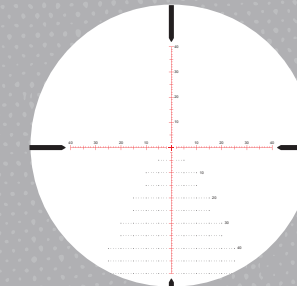

APLR FFP IR-MOA

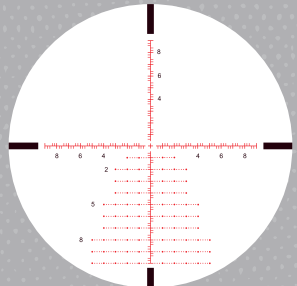

APLR FFP IR-MIL

CRONUS SPECIFICATIONS

POWER X OBJECTIVE LENS	TURRET STYLE	TUBE SIZE	AVAILABLE RETICLES	EYE RELIEF	FOV @100 YARDS	WEIGHT	LENGTH
1-6x24 FFP	CAPPED	30mm	ATSR16 FFP IR MOA	3.9"	95-16 ft	19 oz	10.4"
	EXPOSED		ATSR16 FFP IR MIL				
4.5-29x56 FFP	EXPOSED	34mm	APLR FFP IR MOA	3.6-3.8"	24.8-3.83 ft	35.8 oz	14.4"
			APLR FFP IR MIL				



Advanced Fully Multi-Coated lenses deliver the highest level of light transmission for maximum brightness and true color across the entire light spectrum.



Argon purging gives you better waterproofing and thermal stability



XPL Coating gives you an extra protection on the exterior lenses from dirt, oil and scratches



Waterproof to protect the riflescope in the harshest weather conditions or if accidentally submerged underwater.



Precision Zero Stop System allows you to return to your zero position and dial back to it with a sharp and precise stop right at your zero location

First Focal Plane Reticle stays valid at all power settings allowing you to fully utilize the specially designed reticle that shrinks or grows along with your target as you zoom in or out. The reticle offers quick target engagement at low power while offering precise holdover positions with finer details.

High Precision Erector System processed by high precision CNC machine with +/- 0.0001mm tolerance level to provide you the most accurate power settings and smoothest magnification change

OTHER FEATURES: Side Parallax Adjustment, 6061 - T6 - 30/34mm Tubes, Illuminated Glass Reticles, Capped/Exposed Turrets





First Focal Plane Reticles

RIFlescOPES ARES^{BTR} **NEW**

When you want the best features from the top-tier riflescopes but not break the bank, look no further than the new Ares BTR first focal plane rifle scope family. Starting at \$799, this feature rich rifle scope is set to take the market by storm. Equipped with HD Glass and advanced fully multicoated optics that deliver crisp bright images for taking long range shots. This one piece tube, precision-machined from aircraft-grade 6061-T6 aluminum will deliver precise, accurate results all day long. With a precise true zero stop feature, you won't find another product like this in the market at this price point, it just didn't exist until NOW!



2.5 - 15 X 50MM



4.5 - 27 X 50MM

AVAILABLE RETICLES

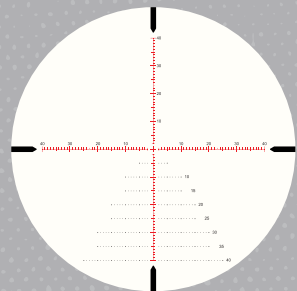

APLR3 FFP IR MOA

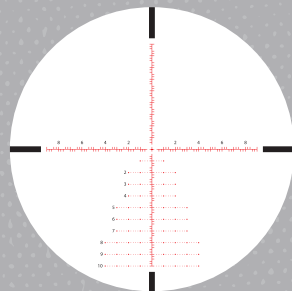

APLR3 FFP IR MIL



ARES^{BTR} SPECIFICATIONS

POWER X OBJECTIVE LENS	TURRET STYLE	TUBE SIZE	AVAILABLE RETICLES	EYE RELIEF	FOV@100 YARDS	WEIGHT	LENGTH
2.5-15X50 FFP	EXPOSED	30mm	APLR3 FFP IR MOA	3.9"	41.8-6.8 ft	27.3 oz	13.8"
			APLR3 FFP IR MIL				
4.5-27X50 FFP	EXPOSED	30mm	APLR3 FFP IR MOA	3.9"	22.7-3.8 ft	27.3 oz	13.8"
			APLR3 FFP IR MIL				



HD Glass gives you the utmost contrast, color reproduction, and the sharpest image.



Advanced Fully Multi-Coated lenses deliver the highest level of light transmission for maximum brightness and true color across the entire light spectrum.



Argon purging gives you better waterproofing and thermal stability



XPL Coating gives you an extra protection on the exterior lenses from dirt, oil and scratches



Waterproof to protect the rifle scope in the harshest weather conditions or if accidentally submerged underwater.



Precision Zero Stop System allows you to return to your zero position and dial back to it with a sharp and precise stop right at your zero location

High Precision Erector System processed by high precision CNC machine with +/- 0.0001mm tolerance level to provide you the most accurate power settings and smoothest magnification change.

The 6061T6 Aircraft Grade Aluminum Tube that has exceptional strength and superior mechanical integrity will protect these world class optics no matter what punishment you throw at it.

OTHER FEATURES: Side Parallax Adjustment, Illuminated Glass Reticles, Exposed Turrets



MIDAS^{BTR} SPECIFICATIONS

POWER X OBJECTIVE LENS	TURRET STYLE	TUBE SIZE	AVAILABLE RETICLES	EYE RELIEF	FOV@100 YARDS	WEIGHT	LENGTH
1-6X24 SFP	CAPPED	30mm	ATSR16 SFP IR MOA ATSR1 SFP IR MOA ATSR16 SFP IR MIL	3.8"	108-17.6 ft	18.1 oz	10.6"
2.5-15X50 SFP	EXPOSED	30mm	AHMR SFP IR MOA APMR1 SFP IR MIL	3.9"	41.8-6.8 ft	26 oz	13.8"
4.5-27X50 SFP	EXPOSED	30mm	AHMR SFP IR MOA APMR1 SFP IR MIL APLR1 SFP IR MIL	3.9"	22.7-3.6 ft	26 oz	13.9"

Second Focal Plane Reticles

RIFLESCOPES MIDAS^{BTR} TACTICAL

Whether you are shooting prairie dogs at 700+ yards or you are shooting 3 gun that replicates life and death scenarios you want a rifle scope that is accurate, tough, durable and extremely versatile. You need a scope with the Midas touch, that makes every shot gold. The Athlon Midas BTR is ready for anything. It is also equipped with our advanced fully multi-coated lenses so you'll have the brightest, clearest long-distance image possible, in any situation. The innovative new XPL coating protects your lenses from oil, dirt and smudges. The 6x magnification ratio eliminates the need for multiple scopes for different game or types of hunting.



1 - 6 X 24MM

2.5 - 15 X 50MM

4.5 - 27 X 50MM

AVAILABLE RETICLES

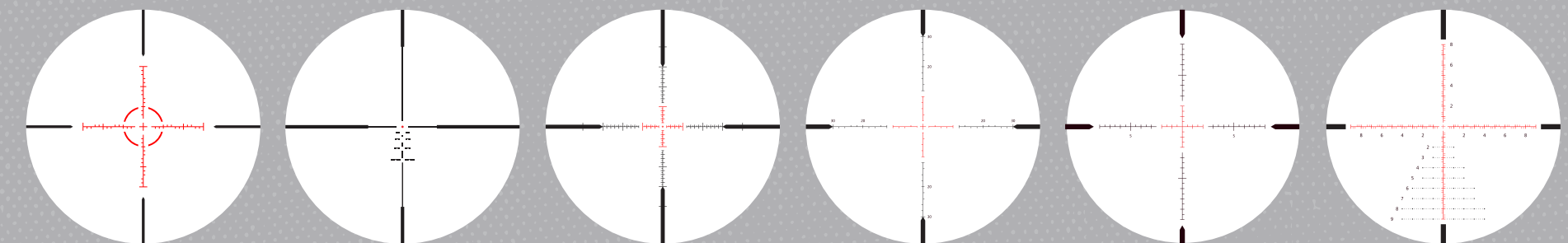

ATSR16 SFP IR MOA ATSR1 SFP IR MOA ATSR16 SFP IR MIL AHMR SFP IR MOA APMR1 SFP IR MIL APLR1 SFP IR MIL



HD Glass gives you the utmost contrast, color reproduction, and the sharpest image.



Advanced Fully Multi-Coated lenses deliver the highest level of light transmission for maximum brightness and true color across the entire light spectrum.



Argon purging gives you better waterproofing and thermal stability



XPL Coating gives you an extra protection on the exterior lenses from dirt, oil and scratches



Waterproof to protect the riflescope in the harshest weather conditions or if accidentally submerged underwater.

High Precision Erector System processed by high precision CNC machine with +/- 0.0001mm tolerance level to provide you the most accurate power settings and smoothest magnification change.

The 6061T6 Aircraft Grade Aluminum Tube that has exceptional strength and superior mechanical integrity will protect these world class optics no matter what punishment you throw at it.

OTHER FEATURES: Side Parallax Adjustment, Illuminated Glass Reticles, Capped/Exposed Turrets





First Focal Plane Reticles

RIFlescOPES HELOS^{BTR} **NEW**

When you hear first focal plane rifle scope, locking turrets, crisp firm turrets, advanced fully multicoated options built from a one piece tube made from aircraft-grade 6061-T6 aluminum you expect it to come with a high price tag. This is exactly why we introduced the Helos BTR family. Feature rich but won't break the bank.



AVAILABLE RETICLES

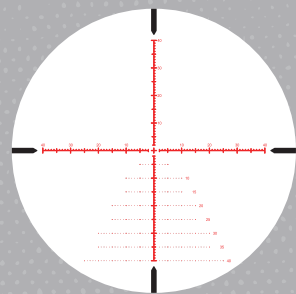

APLR2 FFP IR MOA

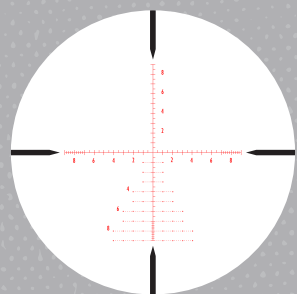

APMR FFP IR MIL

6 - 24 X 50MM

8 - 34 X 56MM



ATHLON OPTICS

HELOS^{BTR} SPECIFICATIONS

POWER X OBJECTIVE LENS	TURRET STYLE	TUBE SIZE	AVAILABLE RETICLES	EYE RELIEF	FOV @100 YARDS	WEIGHT	LENGTH
6-24x50 FFP	EXPOSED	30mm	APLR2 FFP IR MOA APMR FFP IR MIL	3.3"	16.7-4.5 ft	29.7 oz	14.0"
8-34x56 FFP	EXPOSED	30mm	APLR2 FFP IR MOA APMR FFP IR MIL	3.3"	12.5-3 ft	32.3 oz	15.5"



Advanced Fully Multi-Coated lenses deliver the highest level of light transmission for maximum brightness and true color across the entire light spectrum.



Argon purging gives you better waterproofing and thermal stability



XPL Coating gives you an extra protection on the exterior lenses from dirt, oil and scratches



Waterproof to protect the rifle scope in the harshest weather conditions or if accidentally submerged underwater.



Locking Turrets allow you to pull up your turret to dial, and push down the turret to lock it in place.

First Focal Plane Reticle stays valid at all power settings allowing you to fully utilize the specially designed reticle that shrinks or grows along with your target as you zoom in or out. The reticle offers quick target engagement at low power while offering precise holdover positions with finer details.

High Precision Erector System processed by high precision CNC machine with +/- 0.0001mm tolerance level to provide you the most accurate power settings and smoothest magnification change

OTHER FEATURES:
Side Parallax Adjustment, 6061 - T6 - 30 Tubes, Illuminated Glass Reticles, Exposed Turrets



ARGOS BTR SPECIFICATIONS

POWER X OBJECTIVE LENS	TURRET STYLE	TUBE SIZE	AVAILABLE RETICLES	EYE RELIEF	FOV@100 YARDS	WEIGHT	LENGTH
1-4x24 FFP	EXPOSED	30mm	AHSR 14 FFP IR MOA AHSR 14 FFP IR MIL	3.5"	112-27 ft	20.5 oz	9.8"
6-24x50 FFP	EXPOSED	30mm	ATMR FFP IR MOA APMR FFP IR MIL	3.3"	16.7-4.5 ft	29.6 oz	14.1"
8-34x56 FFP	EXPOSED	30mm	ATMR FFP IR MOA APMR FFP IR MIL	3.3"	12.5-3 ft	32.2 oz	15.5"



Advanced Fully Multi-Coated lenses deliver the highest level of light transmission for maximum brightness and true color across the entire light spectrum.



Argon purging gives you better waterproofing and thermal stability



XPL Coating gives you an extra protection on the exterior lenses from dirt, oil and scratches



Waterproof to protect the riflescope in the harshest weather conditions or if accidentally submerged underwater.

■ First Focal Plane Reticles

RIFLESCOPES ARGOS BTR

For those of you that are just getting started in the PRS or are looking to start, take a close look at the Argos BTR family of scopes. These scopes have features normally only found on high-end scopes. It has a 4x magnification that makes it versatile in multiple shooting disciplines. It has our Advanced Fully-Multi Coated Optics that delivers a crystal clear bright image in dark environments. The Argos BTR also has our exclusive XPL coating that protects your lenses from dirt, grease and harsh weather conditions. The 6061T6 aircraft grade aluminum tube will protect these world class optics no matter what punishment you throw at it.



1 - 4 X 24MM



6 - 24 X 50MM



8 - 34 X 56MM

AVAILABLE RETICLES

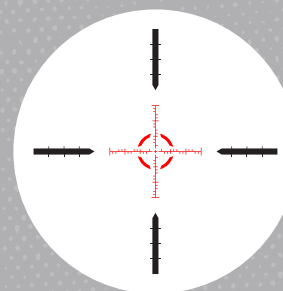

AHSR14 FFP IR MOA

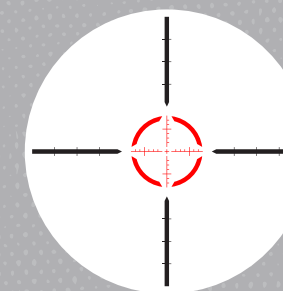

AHSR14 FFP IR MIL

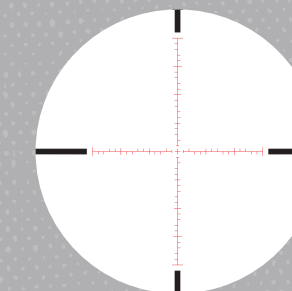

ATMR FFP IR-MOA

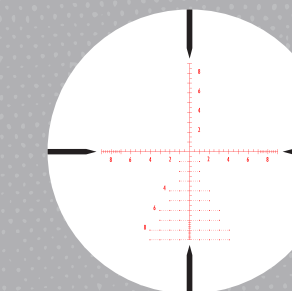

APMR FFP IR-MIL

First Focal Plane Reticle stays valid at all power settings allowing you to fully utilize the specially designed reticle that shrinks or grows along with your target as you zoom in or out. The reticle offers quick target engagement at low power while offering precise holdover positions with finer details.

The 6061T6 Aircraft Grade Aluminum Tube that has exceptional strength and superior mechanical integrity will protect these world class optics no matter what punishment you throw at it.

OTHER FEATURES: Side Parallax Adjustment, Illuminated Glass Reticles, Exposed Turrets

ATHLON OPTICS



Second Focal Plane Reticles

RIFLESCOPES ARGOS

The Argos family of scopes is one of Athlon Optic's most advanced hunting rifle scope lines to date. These scopes have features normally only found on high-end scopes. It has a 5x magnification that makes it versatile in multiple shooting disciplines from up close targets to long range distances. It is equipped with our Fully-Multi Coated Optics that delivers a crystal clear bright image in dark environments. The Argos family also has our exclusive XPL coating that gives you an extra protection on the exterior lenses from dirt, oil and scratches.



2 - 10 X 40MM



3 - 15 X 40MM



4 - 20 X 50MM



6 - 30 X 56MM

AVAILABLE RETICLES

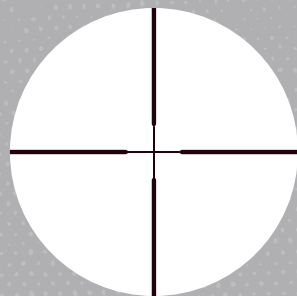

CENTER-X

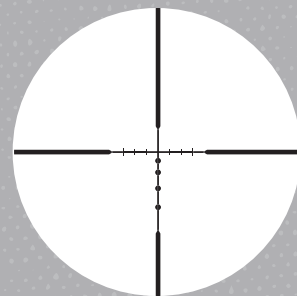

BDC 600

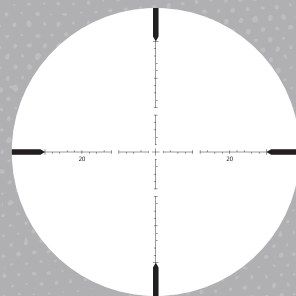

AHMR1 SFP MOA



ATHLON OPTICS

ARGOS SPECIFICATIONS

POWER X OBJECTIVE LENS	TURRET STYLE	TUBE SIZE	AVAILABLE RETICLES	EYE RELIEF	FOV@100 YARDS	WEIGHT	LENGTH
2-10x40 SFP	CAPPED	1"	BDC 600 Center X	>3.8"	48.8-9.8 ft	15.5 oz	12.2"
3-15x40 SFP	CAPPED	1"	BDC 600 Center X	>3.8"	30.4-6.3 ft	16.5 oz	12.2"
4-20x50 SFP	CAPPED	1"	BDC 600 AHMR1 SFP MOA	>3.8"	23.6-4.7 ft	19.5 oz	13.1"
6-30x56 SFP	CAPPED	30mm	BDC 600 AHMR1 SFP MOA	>3.8"	16.6-5.4 ft	22 oz	14.7"



Fully Multi-Coated lenses bring you better light transmission to bring optimum brightness and true color across the entire light spectrum.



Argon purging gives you better waterproofing and thermal stability



XPL Coating gives you an extra protection on the exterior lenses from dirt, oil and scratches



Waterproof to protect the rifle scope in the harshest weather conditions or if accidentally submerged underwater.

Second Focal Plane reticle is located at the second plane which stays in between erector tube and ocular lens. The size or the appearance of a second focal plane reticle does not change when you try to zoom in or zoom out.

The 6063 Aircraft Grade Aluminum provides extra strength and durability to handle the toughest terrain and offers lifetime of use.

OTHER FEATURES:
Side Parallax Adjustment, Capped Turrets



■ First Focal Plane Reticles ■ Second Focal Plane Reticles

RIFLESCOPES TALOS^{BTR}

If you ask any hunter they'll tell you they probably have filled more tags in the low-light hours than any other time. With that said, it would be wise to design a scope to excel in early-morning and late-evening light. With the Talos BTR scope with Athlon Advanced multi-coated lenses for clarity and brightness in low light, you'll be able to add precious minutes to every hunting day that you've worked so hard for. These scopes, with their 4X magnification range, will give you great versatility whether you are hunting whitetails in the dense southern pine forest of Georgia or prairie dogs in the wide open ranges of Wyoming.



1 - 4 X 24MM ■



4 - 14 X 44MM ■

AVAILABLE RETICLES

TALOS^{BTR} RETICLES

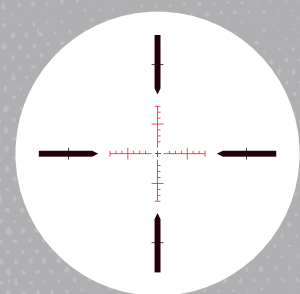

AHSR14 SFP IR MIL

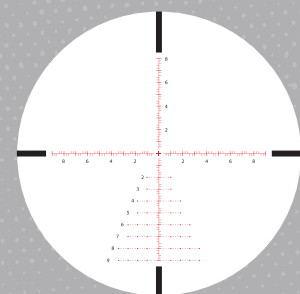

APLR2 FFP IR MIL

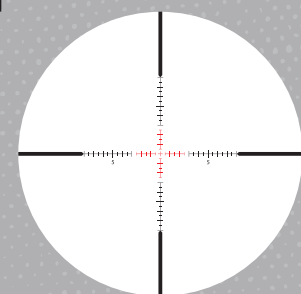

ATMR1 SFP IR MIL

■ Second Focal Plane Reticles

RIFLESCOPES TALOS

If you ask any hunter they'll tell they probably have filled more tags in the low-light hours than any other time. With that said, it would be wise to design a scope to excel in early-morning and late-evening light. With the Talos scope with Athlon Advanced multi-coated lenses for clarity and brightness in low light, you'll be able to add precious minutes to every hunting day that you've worked so hard for. These scopes, with their 4X magnification range, will give you great versatility whether you are hunting whitetails in the dense forest or prairie dogs in the wide open ranges. With its one-piece tube design, the Talos line includes an assortment of specialty scopes for big-game, varmint, MSR's, 22 rimfire, slug, black powder and turkey hunting.



3 - 12 X 40MM ■



4 - 16 X 40MM ■



6 - 24 X 50MM ■

AVAILABLE RETICLES

TALOS RETICLES

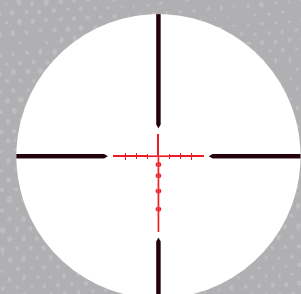

BDC 600 IR

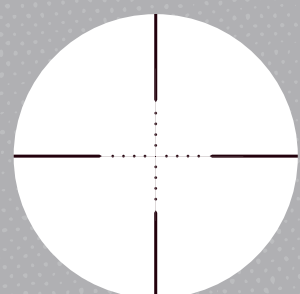

MIL-DOT

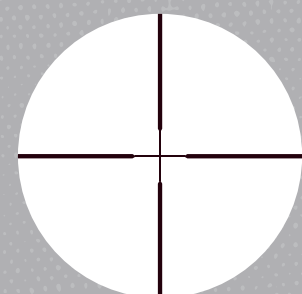

CENTER X

TALOS^{BTR} SPECIFICATIONS

POWER X OBJECTIVE LENS	TURRET STYLE	TUBE SIZE	AVAILABLE RETICLES	EYE RELIEF	FOV@100 YARDS	WEIGHT	LENGTH
1-4x24 SFP	EXPOSED	30mm	AHSR 14 SFP IR MIL	6.26-3.5"	110-26 ft	18 oz	9.2"
4-14x44 FFP	EXPOSED	30mm	APLR2 FFP IR MIL	3.23-3.15"	27.2-7.9 ft	23.6 oz	12.9"



Fully Multi-Coated lenses bring you better light transmission to bring optimum brightness and true color across the entire light spectrum.



Waterproof to protect the riflescope in the harshest weather conditions or if accidentally submerged underwater.

Nitrogen purging dramatically reduces the moisture inside the tube and helps maintaining fogproof and waterproof.

OTHER FEATURES:
Side Parallax Adjustment, 6063 Aluminum - 30mm Tubes, Illuminated Glass Reticles, Exposed Turrets, First/Second Focal Plane



Fully Multi-Coated lenses bring you better light transmission to bring optimum brightness and true color across the entire light spectrum.



Waterproof to protect the riflescope in the harshest weather conditions or if accidentally submerged underwater.

Nitrogen purging dramatically reduces the moisture inside the tube and helps maintaining fogproof and waterproof.

OTHER FEATURES:
Side Parallax Adjustment, 6063 Aluminum - 1 inch Tubes, Illuminated Glass Reticles, Capped Turrets, Second Focal Plane

TALOS SPECIFICATIONS

POWER X OBJECTIVE LENS	TURRET STYLE	TUBE SIZE	AVAILABLE RETICLES	EYE RELIEF	FOV@100 YARDS	WEIGHT	LENGTH
3-12x40 SFP	CAPPED	1"	BDC 600 IR	3.82-3.35"	34.1-8.9 ft	16.2 oz	12"
			Center X				
			Mil-Dot				
4-16x40 SFP	CAPPED	1"	BDC 600 IR	3.8-3.35"	24.1-6.3 ft	19.1 oz	12.9"
			Mil-Dot				
6-24x50 SFP	CAPPED	1"	ATMR1 SFP IR MIL	3.03-3.11"	16.8-4.5 ft	23 oz	13.9"
			BDC 600 IR				

ATHLON OPTICS



Second Focal Plane Reticles

RIFLESCOPES NEOS

Increasing your success while hunting doesn't necessarily have to decrease your savings account. The perfect example of that is the Neos series. This is the perfect scope for those who want quality and features all while staying on budget. The Neos has an impressive list of features which are designed and built to endure. It has a one piece aluminum tube. The lenses are Fully Multi Coated. Finally some of the models even have the latest side parallax even have the latest side parallax technology. What about the cost? Let's just say the scope isn't the only thing that looks good, but still with optics, ruggedness and precision we are proud of.



3 - 9 X 40MM



4 - 12 X 40MM



6 - 18 X 44MM

AVAILABLE RETICLES

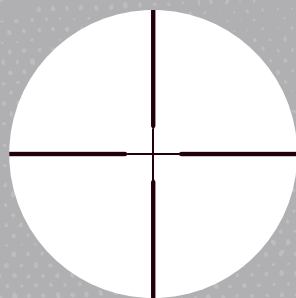

CENTER-X

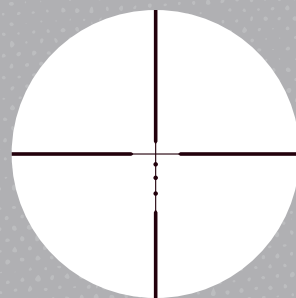

BDC 22 RIMFIRE

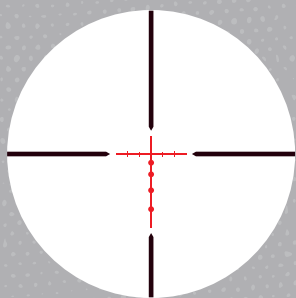

BDC 500 IR



Fully Multi-Coated lenses bring you better light transmission to bring optimum brightness and true color across the entire light spectrum.



Waterproof to protect the riflescope in the harshest weather conditions or if accidentally submerged underwater.

Second Focal Plane reticle is located at the second plane which stays in between erector tube and ocular lens. The size or the appearance of a second focal plane reticle does not change when you try to zoom in or zoom out.

Nitrogen purging dramatically reduces the moisture inside the tube and helps maintaining fogproof and waterproof.

OTHER FEATURES: Side Parallax Adjustment, 6063 Aluminum - 1 inch Tubes, Illuminated Glass Reticles, Capped Turrets



ATHLON OPTICS

NEOS SPECIFICATIONS

POWER X OBJECTIVE LENS	TURRET STYLE	TUBE SIZE	AVAILABLE RETICLES	EYE RELIEF	FOV@100 YARDS	WEIGHT	LENGTH
3-9x40 SFP	CAPPED	1"	Center-X	2.99-3.07"	37.8-12.6 ft	17 oz	12.4"
			BDC 500 IR				
4-12x40 SFP	CAPPED	1"	Center X	3.11-3.15"	27.3-8.9 ft	18.1 oz	12.4"
			BDC 500 IR				
6-18x44 SFP	CAPPED	1"	Center X	3.39-3.19"	17.5-5.9 ft	21.7 oz	13.5"
			BDC 500 IR				



CRONUS SPECIFICATIONS

MAGNIFICATION X OBJECTIVE LENS	EYEPIECE ANGLE	EYE RELIEF	CLOSE FOCUS	FOV @1000 YARDS	WEIGHT	LENGTH X WITDH
20-60x86 ED	45	0.78"	29.5 ft	117-60 ft	66.5 oz	13.6x3.9"
12-36x50 ED	45	0.7"	26.2 ft	171-90 ft	26.5 oz	9.8x2.6"

SPOTTING SCOPES CRONUS

You've just adjusted focus on what had once been only an elusive life-long quest- an Alaskan Bighorn or a red-throated pipit. We developed the Cronus to give you one of world's best spotting scopes with brighter and clearer edge-to-edge detail. So whether you're hunting above timberline in Alaska or birding at sea level at Cape May, you will know every detail of your trophy before you take the shot or mark it off your life list. The Cronus product line has just about every feature you would put in a scope to make it the best you can get in its class.

We designed the Cronus with the Apochromatic system to give your images greater contrast, sharpness and color definition. We included ED Glass that delivers clearer and sharper image to your eyes. Our state of the art ESP (Enhance Spectral Prism) dielectric lens coating that reflects 99% of the light through the prism assembly. Other design enhancements include BaK-4 prisms and our "Advanced Fully Multi-Coated" lenses that deliver flawless color fidelity, ultra-crisp images and optimum light transmission. Finally we topped off with our XPL coating that gives you an extra protection on the exterior lenses from dirt, oil and scratches.



WITH APOCHROMATIC LENS SYSTEM



WITHOUT APOCHROMATIC LENS SYSTEM

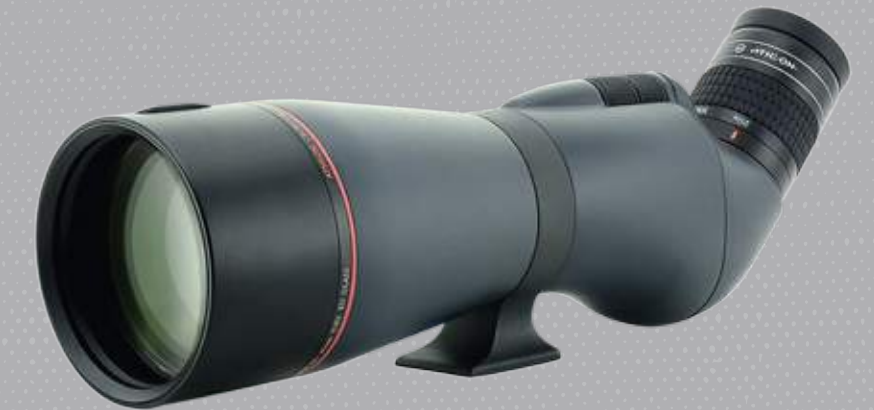

12 - 36 X 50MM ED



20 - 60 X 86MM ED



Apochromatic lens system gives you the result of images which have greater contrast, sharpness and color definition.



Argon purging gives you better waterproofing and thermal stability



ED glass gives you an image with little or no chromatic fringe for a clearer and sharper image



XPL Coating gives you an extra protection on the exterior lenses from dirt, oil and scratches



ESP Dielectric Coating is a multi layer prism coating that reflects over 99% of the light to your eyes bringing you a clear, bright image that displays accurate color reproduction.



BaK-4 glass prisms reflect more light to your eyes thus will give you brighter and sharper image.



Waterproof to protect the spotting scope in the harshest weather conditions or if accidentally submerged underwater.



Advanced Fully Multi-Coated lenses deliver the highest level of light transmission for maximum brightness and true color across the entire light spectrum.



Magnesium chassis give you the strength of a metal chassis while reducing the weight as much as 35%

OTHER FEATURES: Dual Focus, Rotating Ring



SPOTTING SCOPES ARES

The Ares family of spotting scopes were designed with advanced optical quality and ease of use in mind, so when you are trying to collect that trophy of a lifetime, your spotting scope is one thing you don't have to worry about.

We made that task as easy as optically possible with bright, razor-sharp imagery and a rugged, weatherproof design that's ready for any condition. They have ED glass lenses for color resolution and contrast. They also have our AFMC (Advance Fully Multi-Coatings) and feature BaK4 prisms with the new ESP Dielectric Coating. They bring super-premium clarity and brightness within the reach of most avid enthusiasts. The tough chassis is fog proof and waterproof and filled with Argon gas to prevent internal fogging and for better thermal stability. These lenses are then treated externally with our XPL coating to withstand dirt, oil and grime of constant use as well as standing up to the harshest weather conditions.

Choose from three different models - each distinctly different in size so you have a scope tailor-made for your specific activity.



WITH ED GLASS



WITHOUT ED GLASS



7.5 - 22.5 X 50MM ED



15 - 45 X 65MM ED

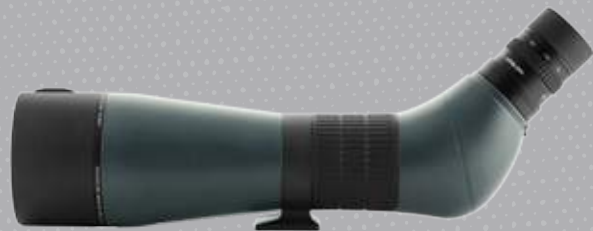

20 - 60 X 85MM ED



ARES SPECIFICATIONS

MAGNIFICATION X OBJECTIVE LENS	EYEPIECE ANGLE	EYE RELIEF	CLOSE FOCUS	FOV @1000 YARDS	WEIGHT	LENGTH X WIDTH
20-60x85 ED	45	0.78"	29.5 ft	102-51 ft	66.5 oz	15.7x3.9"
15-45x65 ED	45	0.78"	13.1 ft	171-81 ft	43.4 oz	9.5x3.5"
7.5-22.5x50 ED	45	0.62"	13.1 ft	265-116 ft	18.9 oz	6.9x2.3"



Apochromatic lens system gives you the result of images which have greater contrast, sharpness and color definition.



Argon purging gives you better waterproofing and thermal stability



ED glass gives you an image with little or no chromatic fringe for a clearer and sharper image



XPL Coating gives you an extra protection on the exterior lenses from dirt, oil and scratches



ESP Dielectric Coating is a multi layer prism coating that reflects over 99% of the light to your eyes bringing you a clear, bright image that displays accurate color reproduction.



BaK-4 glass prisms reflect more light to your eyes thus will give you brighter and sharper image.



Waterproof to protect the spotting scope in the harshest weather conditions or if accidentally submerged underwater.



Advanced Fully Multi-Coated lenses deliver the highest level of light transmission for maximum brightness and true color across the entire light spectrum.



Magnesium chassis give you the strength of a metal chassis while reducing the weight as much as 35%

OTHER FEATURES: Magnesium Chassis (85mm), Rotating Ring



MIDAS^{BTR} RED DOT SIGHT SPECIFICATIONS

AVAILABLE MODELS	OBJECTIVE LENS	MAGNIFICATION	PARALLAX	AVAILABLE RETICLES	DOT COLOR	IR SETTING	CENTER HEIGHT	CLICK VALUE	TURRET CONTROL	BATTERY	BASE	WEIGHT	LENGTH
OS 11	24.5x15.8 mm	1	<2 MOA	OS11	Red	1-6	0.12"	1 MOA	WRENCH	CR2032	Picatinny Rail Mount	2.3 oz	1.93"
RD11	21 mm	1	<2 MOA	ARD11	Red	1-11	0.61"	1 MOA	CAPPED/WRENCH	CR2032	Picatinny Rail Mount	4.8 oz	2.50"
RD12	30 mm	1	<1 MOA	Interchangeable Four Reticles ARD12	Red	1-11	1.40"	1 MOA	CAPPED/WRENCH	CR2032	Picatinny Rail Mount	13.5 oz	5.50"
RD13	36 mm	1	<2 MOA	ARD 13	Red	1-11	1.42"	0.5 MOA	CAPPED/WRENCH	CR2032	Picatinny Rail Mount	11.0 oz	3.70"



Fully Multi-Coated lenses bring you better light transmission to bring optimum brightness and true color across the entire light spectrum.



Waterproof to protect the red dot in the harshest weather conditions or if accidentally submerged underwater.

Nitrogen purging dramatically reduces the moisture inside the tube and helps maintaining fog-proof and waterproof.

OTHER FEATURES: Interchangeable Reticles, Adjustable Illumination Settings, Aircraft Aluminum, One Piece Chassis Construction, Fog proof, Shockproof, Picatinny Rail Mount

RED DOT SIGHTS MIDAS^{BTR}

Whether you are hunting turkeys or shooting three gun with your favorite MSR, you often have to shoot fast when the opportunity is there. If you're looking for a fast sight, you'll be hard-pressed to find one quicker than one of the Athlon Red Dot scopes.

Use by the military for a long time, a red dot scope lets you bead up on a target as quickly as you can raise your gun. Put the "red dot" on the target and pull the trigger. It's that fast. A red dot scope illuminates the point of impact on the target in front of you, yet no forward light is projected giving away your position. Sight from any distance behind the gun without taking both eyes off of the target. Offers unlimited eye relief and an unlimited field-of-view.

It fits easily on handguns, shotguns and rifles with a standard Weaver-style bases or mounts. If you are within 40 yards of a bird and you can get the red dot on his vital area, you will be eating wild turkey for dinner.



OS11 (24.5 X 15.8MM OBJ.)



RD11 (21MM OBJ.)



RD12 (30MM OBJ.)



RD13 (36MM OBJ.)

AVAILABLE RETICLES

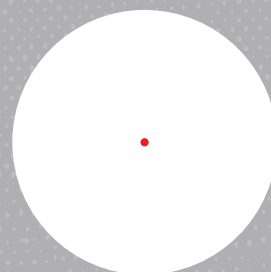

OS11 & ARD11

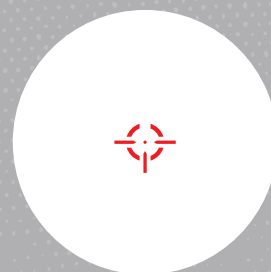

ARD13

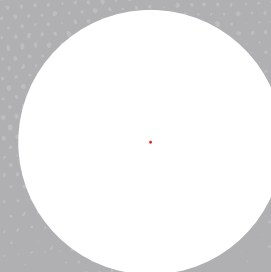

ARD12 - 1

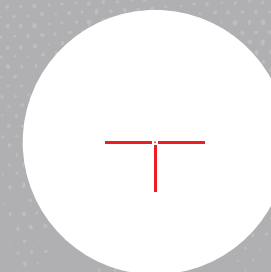

ARD12 - 2

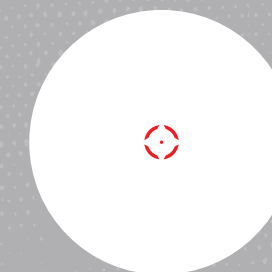

ARD12 - 3

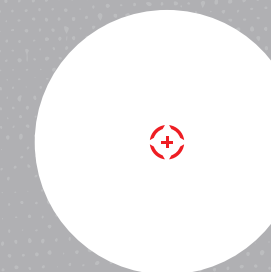

ARD12 - 4



PRISM SCOPES MIDAS^{BTR}

When you want quick target acquisition at both short and medium ranges you need some additional magnification. The Athlon Prism red dot scopes give you great versatility. These devices are equipped with a Prisms for crisp, vivid imaging. The prism-based design allows for a more compact scope without sacrificing optical quality. With this longer focal length we can achieve the magnification needed to reach out and touch targets at longer ranges. The Athlon Prism Red Dots are nitrogen-filled, fog proof and shock proof, allowing for reliable use in a wide range of environments. Selectable red/green illuminated reticles with intensity levels to match specific conditions. The reticles are etched directly on the prism to make sure you have consistent point-of-aim at all times, whether you have the illumination on or off. The scopes come with a Picatinny rail mounting bracket for AR's with a flattop.



PR31 (32MM OBJ.)



PR11 (30MM OBJ.)



PR41 (34MM OBJ.)

AVAILABLE RETICLES

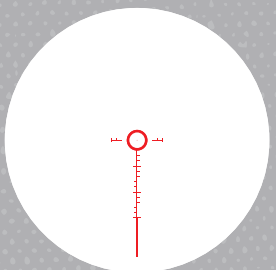

APSR41

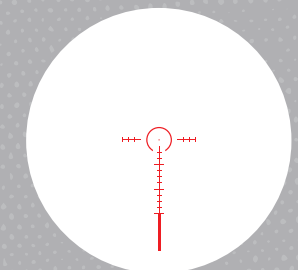

APSR31

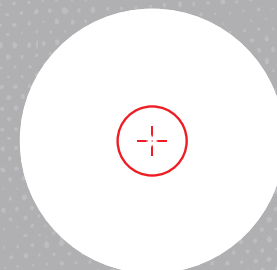

APSR11



ATHLON OPTICS

MIDAS^{BTR} PRISM SCOPE SPECIFICATIONS

AVAILABLE MODELS	OBJECTIVE LENS	MAGNIFICATION	FOV @100 YARDS	AVAILABLE RETICLES	DOT COLOR	CENTER HEIGHT	CLICK VALUE	TURRET CONTROL	BATTERY	BASE	WEIGHT	LENGTH
PR11	30 mm	1	78.8 ft	APSR11	Red/Green	1.41"	1 MOA	EXPOSED DIRECT DIAL	CR2032	Picatinny Rail Mount	13.4 oz	4.70"
PR31	32 mm	3	32.5 ft	APSR31	Red/Green	1.40"	0.5 MOA	EXPOSED DIRECT DIAL	CR2032	Picatinny Rail Mount	15.8 oz	4.80"
PR41	34 mm	3.9	24.9 ft	APSR41	Red/Green	1.40"	0.5 MOA	EXPOSED DIRECT DIAL	CR2032	Picatinny Rail Mount	17.3 oz	5.75"



Fully Multi-Coated lenses bring you better light transmission to bring optimum brightness and true color across the entire light spectrum.



Waterproof to protect the prism scope in the harshest weather conditions or if accidentally submerged underwater.

Nitrogen purging dramatically reduces the moisture inside the tube and helps maintaining fog-proof and waterproof.

OTHER FEATURES: Adjustable Illumination Settings, Aircraft Aluminum, One Piece Chassis Construction, Fog proof, Shockproof, Picatinny Rail Mount



MAGNIFIERS MIDAS

Many times when in the field or during competitions you need to transition between no magnification for speed in close-range combat and magnification for precision shooting as situation dictates. The Athlon 3 or 5 power magnifier mounts behind a traditional red-dot sight to provide magnification when needed. The mount has the ability to swing out of the way when not in use, but can quickly be placed behind the red dot to increase the magnification for longer mid-range shots. Rugged construction. Multi-coated lenses and 30mm tube for excellent light transmission. Nitrogen purged, shockproof, waterproof, and fogproof.



MG31 (27.5MM OBJ.)



MG51 (30MM OBJ.)



MG31 - FLIP MOUNT WITH RISER



MG51 - FLIP MOUNT WITH RISER

MIDAS MAGNIFIER SPECIFICATIONS

AVAILABLE MODELS	OBJ. LENS DIA.	MAGNIFICATION	FOV @100 YARDS	EYE RELIEF	WEIGHT	LENGTH	*CENTER HEIGHT	**CENTER HEIGHT
MG31	27.5 mm	3	38.2 ft	2.8"	9.5 oz	4.2"	1.32"	1.56"
MG51	30 mm	5	24.7 ft	2.6"	12.6 oz	4.8"	1.32"	1.56"

* Standard flip mount

** Standard flip mount with riser

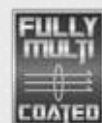

Fully Multi-Coated lenses bring you better light transmission to bring optimum brightness and true color across the entire light spectrum.



Waterproof to protect the magnifier in the harshest weather conditions or if accidentally submerged underwater.

The Aircraft Grade Aluminum that has exceptional strength and superior mechanical integrity will protect these world class optics no matter what punishment you throw at it.

One Piece Chassis Construction gives the scope extra strength. A one piece Chassis also is better at keeping moisture out thus keeping your scope fog proof for the life of the product

Fog Proof to allow you to immediately engage your target when you take your rifle to cold ambient temperature from warm inside

Shockproof - Robust mechanical system with special designs on both control and erector system that give you the ultimate recoil resistance to withstand 600G recoil for 1000 times.

Nitrogen purging dramatically reduces the moisture inside the tube and helps maintaining fogproof and waterproof.



LASER RANGEFINDER MIDAS 1200Y **NEW**

The Athlon Optics Midas 1200y Laser Rangefinder is in a class of its own. The Midas 1200 ranges quick and accurate from 5 to 1200 yards. Whether shooting from steep elevations to flat ground, the Midas is capable of both with our angle compensation and line of sight modes. The scan mode can quickly scan different objects for distances on the fly. Bright display settings with fully multi-coated lenses deliver maximum light transmission while being housed in durable non slip rubber armor. The Midas can display readings in either yards or meters depending on your hunting or shooting needs. Finally the Midas comes with a protective carrying case as well as a protective wrap that allows you to use the laser while protecting it at the same time.

AVAILABLE COLORS



MIDAS 1200Y - GREY



MIDAS 1200Y - TAN

MIDAS 1200Y SPECIFICATION

RANGING REFLECTIVE	RANGING DEER	ACCURACY	MAX ANGLE READING	MAGNIFICATION	OBJ. LENS DIAMETER	FOV	EYE RELIEF	POWER SUPPLY
1200Y	600Y	±0.5Y	±70 degrees	6X	23.5mm	7 degrees	14mm	CR2-3V



Fully Multi-Coated lenses bring you better light transmission to bring optimum brightness and true color across the entire light spectrum.



Waterproof to protect the laser rangefinder in the harshest weather conditions or if accidentally submerged underwater.

Nitrogen purging dramatically reduces the moisture inside the tube and helps maintaining fog-proof and waterproof.

OTHER FEATURES:
Tripod Adaptable, Scan Mode, Dual Units of Measurement of Distance (Y/M), Angle Compensation Mode, Diopter Adjustment, Rubber Armor.

THREE RANGING MODES TO CHOOSE FROM



INCLINE ANGLE



VERTICAL DISTANCE



TRUE HORIZONTAL DISTANCE

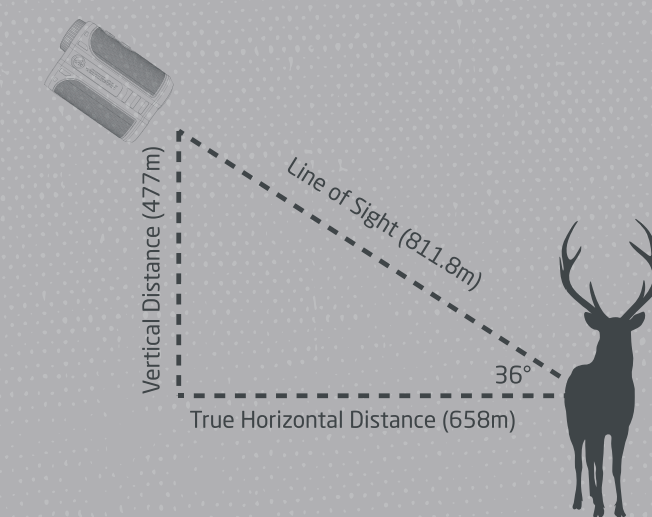



ACCESSORIES

BINOCULAR HARNESS NEW

The Athlon Optics Binocular Harness is the most functional, versatile binocular system in the market. It holds your binoculars tight to your chest, and is designed for quite, one-handed use.

Whether carrying a rifle or bow in one hand, the harness can easily be opened with your free hand and use your binoculars for the moment that counts. With the multiple shoulder and neck adjustments, this allows the binocular harness to hold close to your chest and prevent sag and bounce when crawling or running. The harness allows for a full range of motion while the binoculars are in use.



BINOCULAR TRIPOD ADAPTER

Mount a binocular to regular camera tripod, for added stability and convenience. Make a binocular stable on the tripod, for viewing with no tremble.

High quality aluminum: Solid and light weight

1/4" threading at the top compatible with most tripod-adaptable binoculars.



SCOPE SUNSHADE

Available for Cronus BTR, Cronus, Ares BTR, Midas BTR, Helos BTR, Argos BTR, and Talos BTR riflescopes, black matte surface finish, and 4.5 inches long (sizes in 56, 50, 44mm).



BINOCULAR HARNESS FEATURES

Magnetic Fold Down Cover for quick, quite and easy access. Water tight and dust proof

Side Hook and Stretch Cord for attaching the laser rangefinder and securing it to the harness.

Front Strap Attachment for securing your laser rangefinder or other accessories while hiking

Adjustable Straps - Flex and Non-flex, help keep binoculars in place and from bouncing around

Side Pocket, Clip and Hook provide additional storage and quick access to game calls and other hunting accessories



RIFLESCOPE CRONUS^{BTR} **NEW**

Cronus BTR riflescopes just got better. Upgraded parallax adjustment settings from 25 yards to infinity (added markings at 300, 500, 800 and 1600 yards), redesigned battery compartment and developed a new long range reticle will set this in a class above the rest. It is still built on a ultra-strong one-piece tubes, equipped with a 6x magnification ratio, advanced HD optical system along with our XPL coatings and argon purged waterproofing has not changed.



APRS FFP IR MIL reticle is designed for precision rifle series competition and any other long range shooting applications with accurate ranging capability. It can help you quickly determine distance, holdover positions, windage correction and leads for a moving target. The unique design of fine .2 mil hash mark increments from center to 6 mils to both left and right helps the shooter set a quick windage holdover position after he or she dialed in elevation on their targets. The floating 0.4 mil span center cross draws a shooter's vision right on target enabling him or her to engage a target at a blink of an eye.

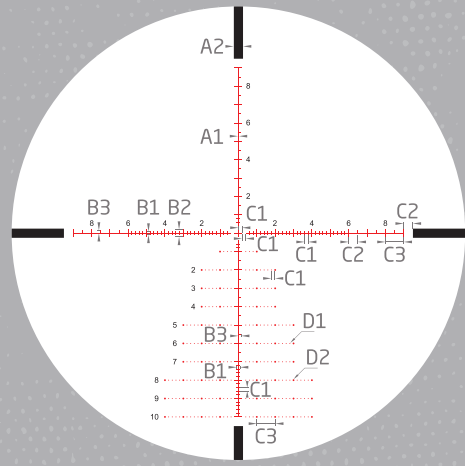

APRS FFP IR MIL

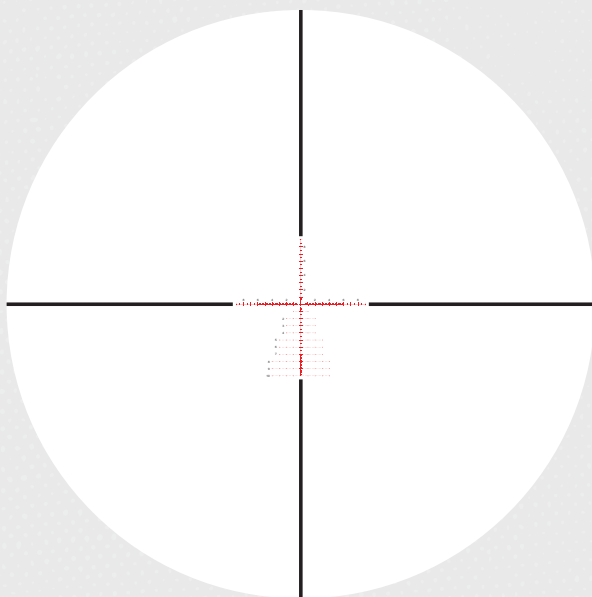

4.5X

APRS FFP IR MIL

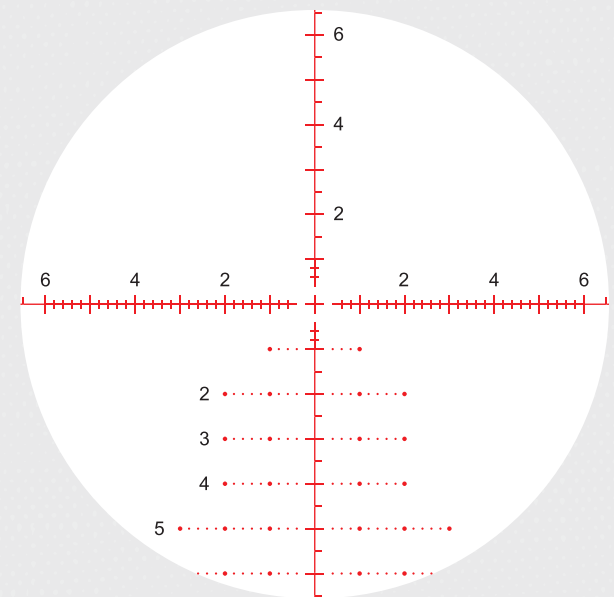

29X

APRS FFP IR MIL

RIFLESCOPE DIMENSIONS

RIFLESCOPE MODEL	L1	L2	L3	L4	L5	L6	D1	D2
4.5-29x56 FFP	14.4	3.9	6.3	4.2	2.6	2	1.8	2.6

*** dimensions are given in inches*

RETICLE SUBTENSIONS

APRS FFP IR MIL	A1	A2	B1	B2	B3	C1	C2	C3	D1	D2
SUBTENSIONS IN MIL	.03	.05	.18	.4	.15	.2	.5	1	.05	.1

DETAILED SPECS

POWER X OBJECTIVE LENS	TURRET STYLE	TUBE SIZE	AVAILABLE RETICLES	SURFACE FINISH	EYE RELIEF	FOV @100 YARDS	WEIGHT	LENGTH	CLICK VALUE	ADJ. RANGE PER ROTATION	TOTAL ELEV. ADJ.	TOTAL WINDAGE ADJ.	PARALLAX ADJ.	PURGING MATERIAL
4.5-29X56 FFP	EXPOSED	34mm	APRS FFP IR MIL	MATTE	3.6-3.8"	24.8-3.83 ft	35.8 oz	14.4"	0.1 MIL	10 MIL	32 MIL	18 MIL	SIDE FOCUS 25yds - ∞	ARGON



RIFLESCOPE CRONUS

Cronus riflescopes are built on ultra-strong one-piece tubes, equipped with a 6x magnification ratio which eliminated the need for multiple scopes for different game or types of hunting. The advanced HD optical system along with our XPL coatings and argon purged waterproofing makes this scope one of a kind.



ATSR16 FFP IR MOA reticle has a 2 moa illuminated center cross and 20 moa illuminated center circle, which offers great low light visibility and help you quickly lock in your target and set holdover positions. The illuminated 20-moa-span center circle and a 2 moa center cross with regular 2 moa incremental hash marks extended to 30 moa at each direction on both vertical and horizontal lines provides a unique two layer visual reference that helps the shooter quickly locate the target and lock it on the center within a blink of an eye.

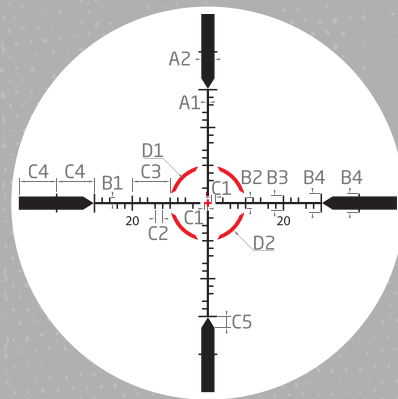

ATSR16 FFP IR MOA

ATSR16 FFP IR MIL reticle is designed to maximize your performance on short and mid-range shooting with an illuminated 10 mil diameter circle that offers great low light visibility, 1 mil center cross and cross lines with 0.5 mil hash mark incremental. The reticle at 1x becomes a red dot circle that can be used effectively for short range target, while at 6x it offers greater details with 0.5 mil hash mark that will help shooters quickly spot their target and set holdover positions.

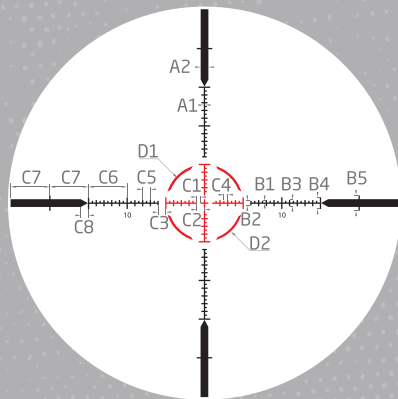

ATSR16 FFP IR MIL

RIFLESCOPE DIMENSIONS

RIFLESCOPE MODEL	L1	L2	L3	L4	L5	L6	D1	D2
1-6x24 FFP	10.4	/	6.6	3.8	2.2	2.7	1.8	1.2

** dimensions are given in inches

RETICLE SUBTENSIONS

ATSR16 FFP IR MOA	A1	A2	B1	B2	B3	B4	C1	C2	C3	C4	C5	D1	D2				
SUBTENSIONS IN MOA	.4	3.5	1.5	3	4	5	1	2	10	10	3	18	20				
ATSR16 FFP IR MIL	A1	A2	B1	B2	B3	B4	B5	C1	C2	C3	C4	C5	C6	C7	C8	D1	D2
SUBTENSIONS IN MIL	.17	1	.3	.6	.8	1.5	2	.5	1	1	.5	1	5	5	1	9.4	10

DETAILED SPECS

POWER X OBJECTIVE LENS	TURRET STYLE	TUBE SIZE	AVAILABLE RETICLES	SURFACE FINISH	EYE RELIEF	FOV @100 YARDS	WEIGHT	LENGTH	CLICK VALUE	ADJ. RANGE PER ROTATION	TOTAL ELEV. ADJ.	TOTAL WINDAGE ADJ.	PARALLAX ADJ.	PURGING MATERIAL
1-6X24 FFP	CAPPED EXPOSED	30mm	ATSR16 FFP IR MOA ATSR16 FFP IR MIL	MATTE	3.9"	95-16 ft	19 oz	10.4"	0.5 MOA 0.2 MIL	50 MOA 20 MIL	160 MOA 50 MIL	160 MOA 50 MIL	FIXED 100 yds	ARGON

1X

ATSR16 FFP IR MOA

6X

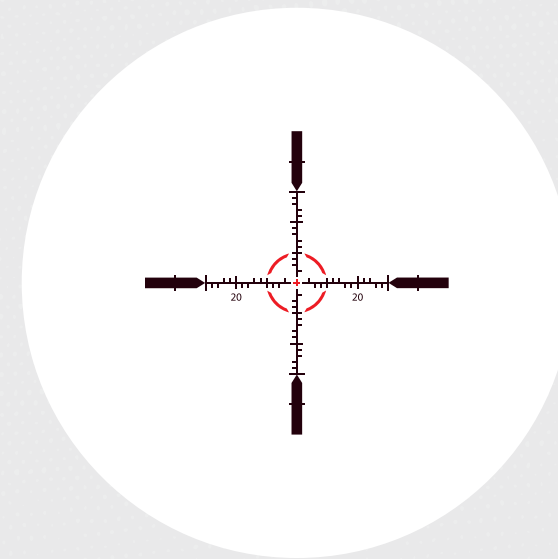
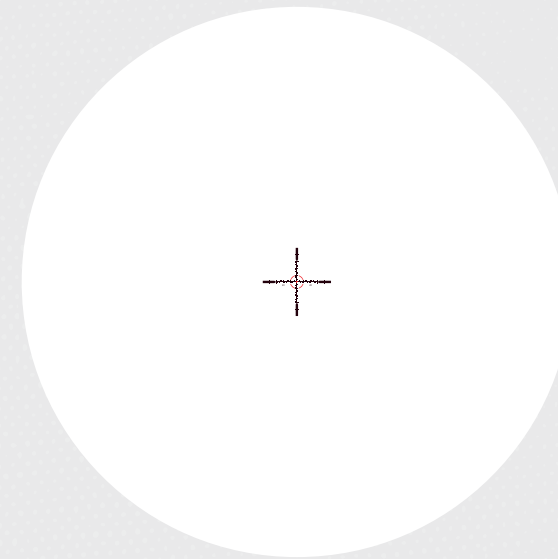

1X

ATSR16 FFP IR MIL

6X

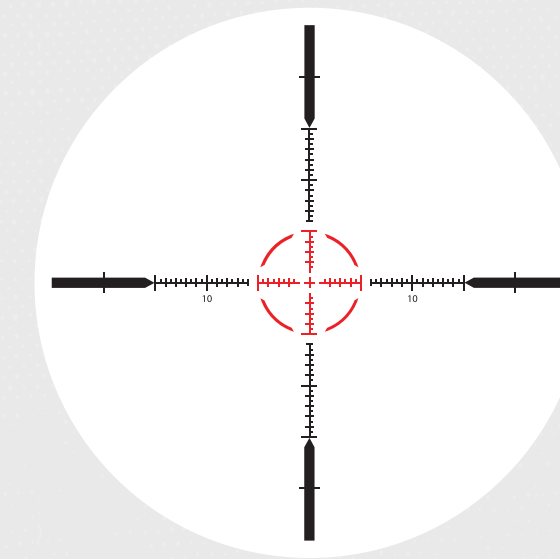
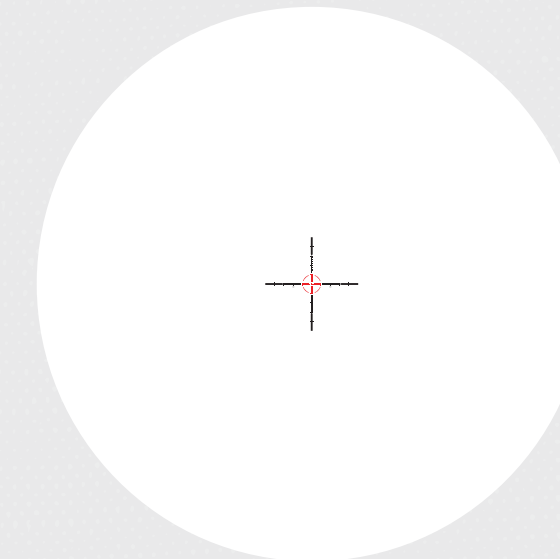



RIFLESCOPE CRONUS

Cronus riflescopes are built on ultra-strong one-piece tubes, equipped with a 6x magnification ratio which eliminated the need for multiple scopes for different game or types of hunting. The advanced HD optical system along with our XPL coatings and argon purged waterproofing makes this scope one of a kind.

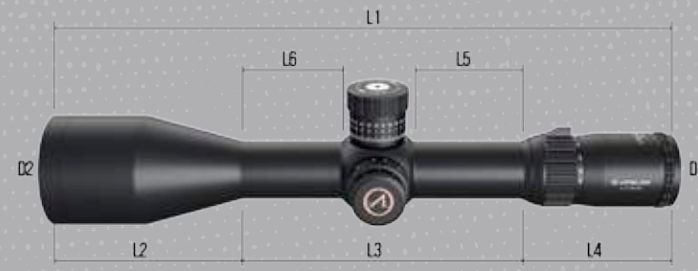

APLR FFP IR MOA reticle has a large illuminated center with 1 moa incremental hash marks and drop lines in 5 moa incremental on vertical direction down to 50 moa, which help you quickly lock in your target and set holdover positions. The illuminated portion has a 2 moa center cross and 40 moa cross lines (50 moa on lower vertical line). The drop lines have smaller dots with 1 moa in between and bigger dots at each 5 moa interval. The illuminated reticle provides excellent low light visibility and accurate elevation holdovers all the way up to 50 moa.

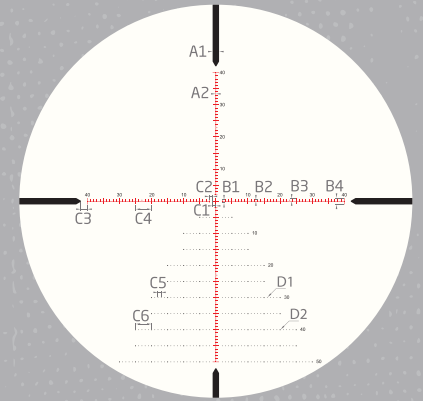

APLR FFP IR MOA

APLR FFP IR MIL reticle is designed to maximize your performance on precision long-distance shooting with accurate ranging capability. The reticle can help you quickly determine distance, holdover positions, windage correction and leads for a moving target. Having .2 & .4 Mil and .6 and .8 Mil on different side of cross lines helps a shooter quickly locate a holdover position within a blink of an eye. The illuminated fine reticle provides excellent low light visibility and windage holdovers on the bullet droplines all the way up to 10 mils with .2 mil mark incremental.

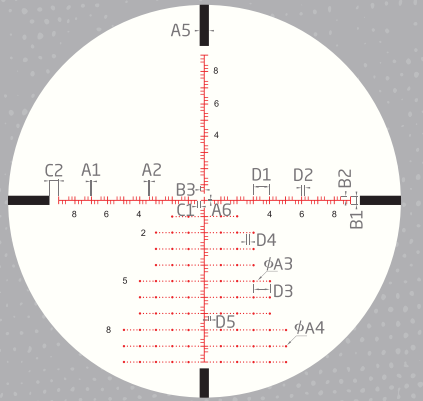

APLR FFP IR MIL

RIFLESCOPE DIMENSIONS

RIFLESCOPE MODEL	L1	L2	L3	L4	L5	L6	D1	D2
4.5-29x56 FFP	14.4	3.9	6.3	4.2	2.6	2	1.8	2.6

** dimensions are given in inches

RETICLE SUBTENSIONS

APLR FFP IR MOA	A1	A2	B1	B2	B3	B4	C1	C2	C3	C4	C5	C6	D1	D2		
SUBTENSIONS IN MOA	2	.14	1	.5	1.5	2	1	1	2	5	1	5	.2	.3		
APLR FFP IR MIL	A1	A2	A3	A4	A5	A6	B1	B2	B3	C1	C2	D1	D2	D3	D4	D5
SUBTENSIONS IN MIL	.04	.04	.05	.1	.5	.04	.4	.2	.2	.2	.5	1	.2	1	.2	.2

DETAILED SPECS

POWER X OBJECTIVE LENS	TURRET STYLE	TUBE SIZE	AVAILABLE RETICLES	SURFACE FINISH	EYE RELIEF	FOV @100 YARDS	WEIGHT	LENGTH	CLICK VALUE	ADJ. RANGE PER ROTATION	TOTAL ELEV. ADJ.	TOTAL WINDAGE ADJ.	PARALLAX ADJ.	PURGING MATERIAL
4.5-29X56 FFP	EXPOSED	34mm	APLR FFP IR MOA APLR FFP IR MIL	MATTE	3.6-3.8"	24.8-3.83 ft	35.8 oz	14.4"	0.25 MOA 0.1 MIL	25 MOA 10 MIL	110 MOA 32 MIL	64 MOA 18 MIL	SIDE FOCUS 25yds - ∞	ARGON

4.5X

APLR FFP IR MOA

29X

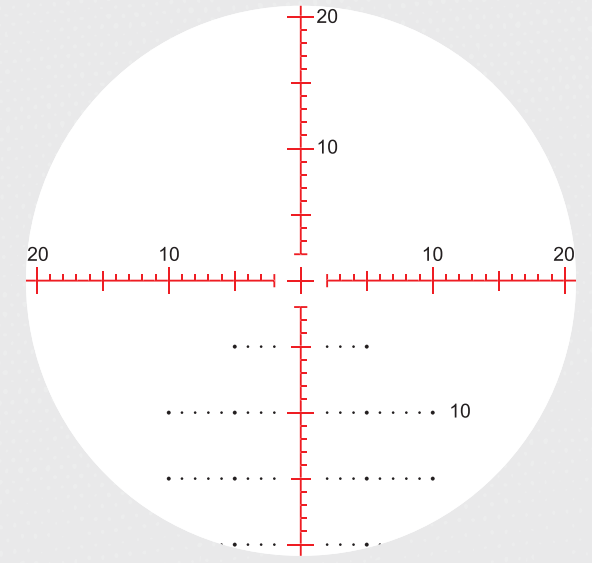
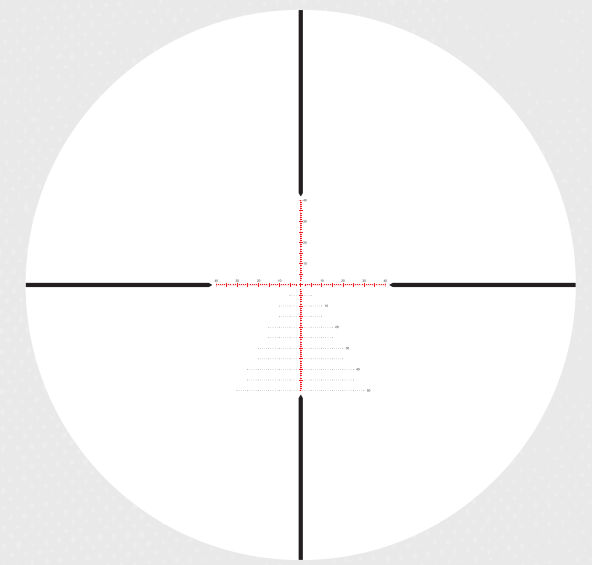

4.5X

APLR FFP IR MIL

29X

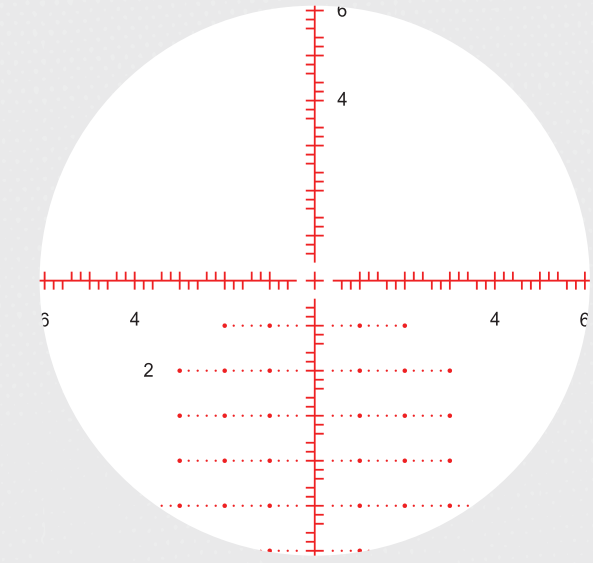
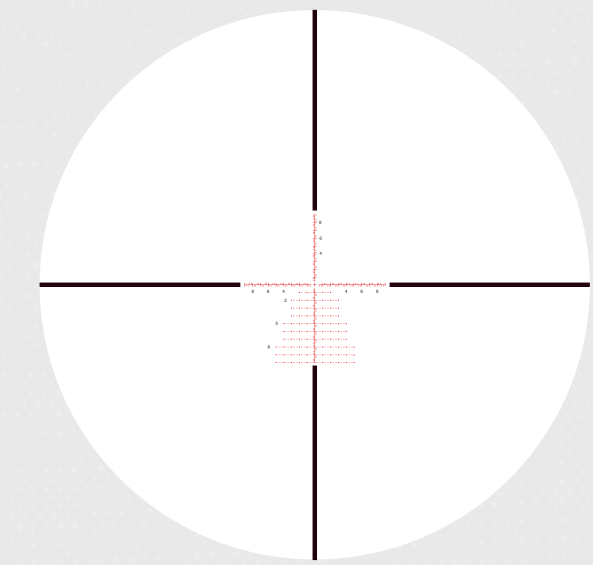



RIFLESCOPE ARES^{BTR} **NEW**

The new Ares BTR rifle scope family will deliver in every category - Features, design, performance, reliability, durability, trackability, repeatability, and best PRICE! You heard it. You can now have your cake and eat it too with the Ares BTR family. 6x magnification, HD glass, Advanced FMC, side parallax adjustment, XPL coating, 6061-T6 30mm once piece tube, argon purged waterproof, illuminated reticle, true zero stop, first focal plane scope.

APLR3 FFP IR MOA reticle has a large illuminated center with 1 moa hash mark increments and drop lines in 5 moa increment on vertical direction down to 40 moa, both of which help you quickly lock in your target and set holdover positions. The illuminated portion has a 2 moa span center cross with illuminated cross line extends to 40 moa on both vertical and horizontal direction. The unique design of having droplines going down to 40 moa with 5 moa between each drop line and 1 moa hash marks in between provide excellent holding over positions for long precision shooting.

APLR3 FFP IR MIL reticle can help you quickly determine distance, holdover positions, windage correction and leads for a moving target. The unique design of fine .2 mil hash mark increments from center all the way to four directions helps the shooter set a precise holdover position for their targets within a blink of an eye. The illuminated fine reticle provides excellent low light visibility and windage holdovers on the bullet droplines all the way up to 10 mils with .2 mil marks increments in between.

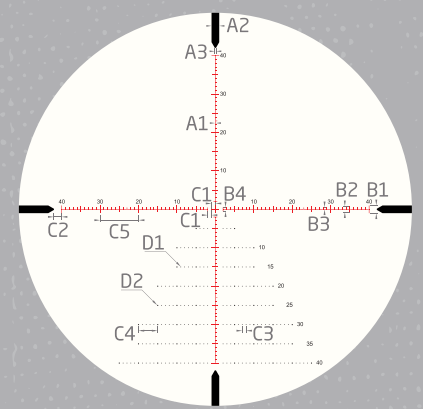
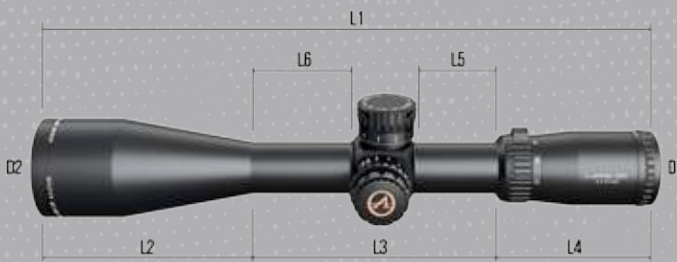

APLR3 FFP IR MOA

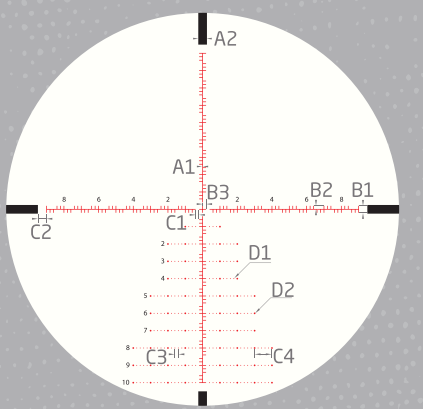

APLR3 FFP IR MIL

RIFLESCOPE DIMENSIONS

RIFLESCOPE MODEL	L1	L2	L3	L4	L5	L6	D1	D2
2.5-15x50 FFP	13.8	4.7	5.5	3.6	1.8	2.2	1.8	2.3
4.5-27x50 FFP	13.8	4.7	5.5	3.6	1.8	2.2	1.8	2.3

** dimensions are given in inches

RETICLE SUBTENSIONS

APLR3 FFP IR MOA	A1	A2	A3	B1	B2	B3	B4	C1	C2	C3	C4	C5	D1	D2	CONFIGURATION
SUBTENSIONS IN MOA	.24	2	.3	2	1.5	.5	1	1	2	1	5	10	.2	.3	2.5-15x50
APLR3 FFP IR MOA	A1	A2	A3	B1	B2	B3	B4	C1	C2	C3	C4	C5	D1	D2	CONFIGURATION
SUBTENSIONS IN MOA	.14	2	.3	2	1.5	.5	1	1	2	1	5	10	.2	.3	4.5-27x50
APLR3 FFP IR MIL	A1	A2	B1	B2	B3	C1	C2	C3	C4	D1	D2	CONFIGURATION			
SUBTENSIONS IN MIL	.07	.5	.4	.2	.2	.2	.5	.2	1	.09	.14	2.5-15x50			
APLR3 FFP IR MIL	A1	A2	B1	B2	B3	C1	C2	C3	C4	D1	D2	CONFIGURATION			
SUBTENSIONS IN MIL	.04	.5	.4	.2	.2	.2	.5	.2	1	.05	.1	4.5-27x50			

DETAILED SPECS

POWER X OBJECTIVE LENS	TURRET STYLE	TUBE SIZE	AVAILABLE RETICLES	SURFACE FINISH	EYE RELIEF	FOV @100 YARDS	WEIGHT	LENGTH	CLICK VALUE	ADJ. RANGE PER ROTATION	TOTAL ELEV. ADJ.	TOTAL WINDAGE ADJ.	PARALLAX ADJ.	PURGING MATERIAL
2.5-15X50 FFP	EXPOSED	30mm	APLR3 FFP IR MOA	MATTE	3.9"	41.8-6.8 ft	27.3 oz	13.8"	0.25 MOA	25 MOA	100 MOA	100 MOA	SIDE FOCUS 10yds - ∞	ARGON
			APLR3 FFP IR MIL											
4.5-27X50 FFP	EXPOSED	30mm	APLR3 FFP IR MOA	MATTE	3.9"	22.7-3.8 ft	27.3 oz	13.8"	0.25 MOA	25 MOA	80 MOA	80 MOA	SIDE FOCUS 25yds - ∞	ARGON
			APLR3 FFP IR MIL											

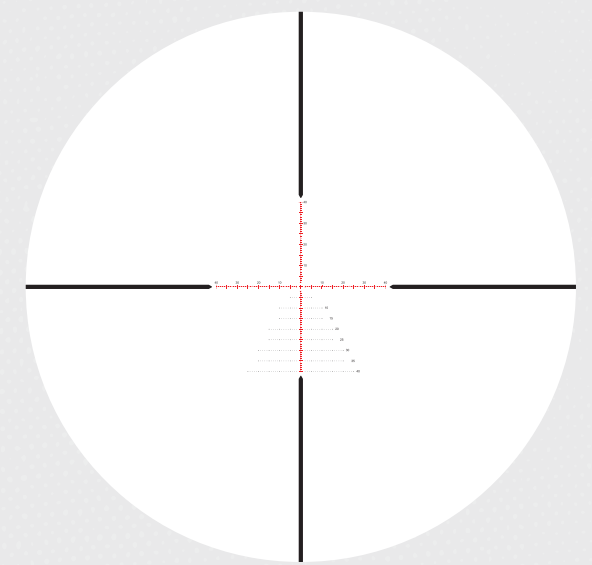

4.5X

APLR3 FFP IR MOA

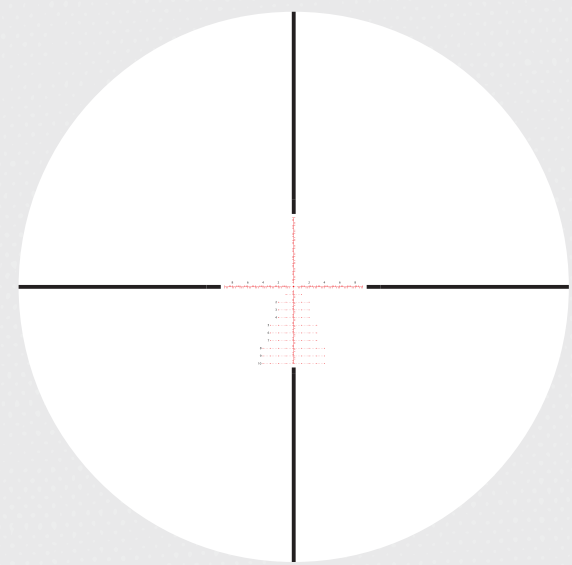

4.5X

APLR3 FFP IR MIL

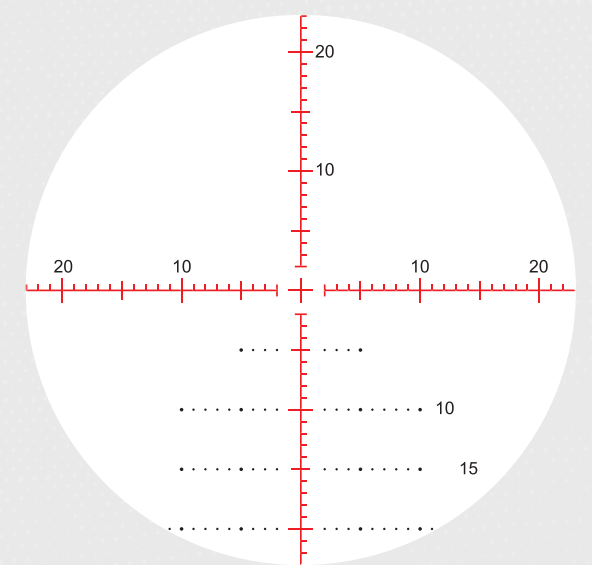

27X

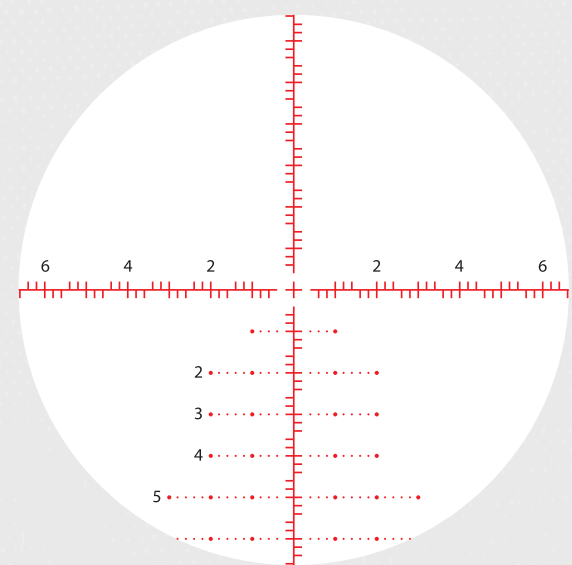

27X



RIFLESCOPE MIDAS^{BTR}

The Midas BTR is ready for anything you can throw at it. From tip to tip, this scope has it all. HD glass, FMC optics, XPL coatings, and argon gas purged makes this scope waterproof and fog proof. Add all of these features together and you get an excellent scope that should break the bank, but won't!



ATSR16 SFP IR MOA reticle has a large illuminated center and 2 moa incremental hash marks, which help you quickly lock in your target and set holdover positions. The illuminated center with a 20 moa diameter circle in the middle has a 2 moa center cross and 2 moa incremental hash marks extended to 30 moa at each direction on both vertical and horizontal lines. The cross lines, middle circle, and center cross provide a unique three layer visual reference for a shooter to locate the target and set dead on the center cross within a blink of an eye.

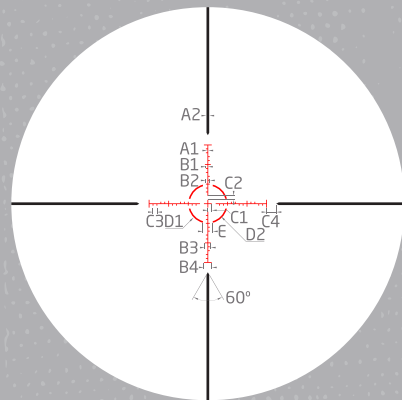

ATSR16 SFP IR MOA

The **ATSR1 SFP IR MOA** reticle is specifically designed for 3 gun competition (68 grain horny and 69 grain sierra cartridge) and any Nato 5.56/.223 caliber rifle with hold over points for both bullet drop and wind. The 1 moa red dot is perfect for zeroing your rifle at 200 yard and the open centers below the center red dot are for targets at 300, 400, 500, and 600 yard. The unique design of open centers does not block any 12~18 inch targets beyond 200 yards and allows a shooter to take a quick shot once a target fills up the gap in the middle.

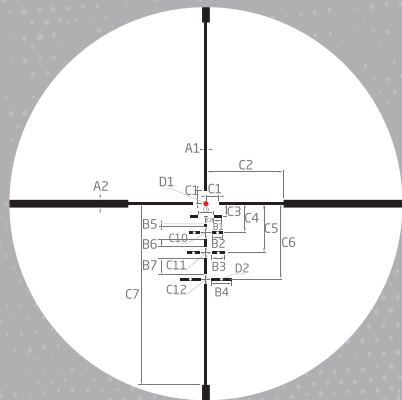

ATSR1 SFP IR MOA

ATSR 16 SFP IR MIL reticle is designed to maximize your performance on short and mid-range shooting with illuminated center cross and 0.5 mil hash marks incremental extended to 5 mils. The illuminated 10 mil center with a 0.5 mil center cross and 0.5 mil hash marks provide a unique two layer visual reference. The illuminated portion of the reticle provides excellent low light visibility and the total 30 mil reticle span with 0.5 mil incremental offers accurate holdover positions.

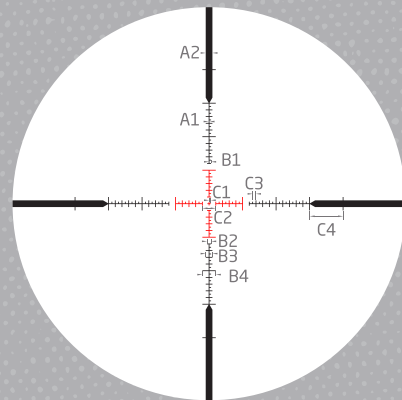

ATSR16 SFP IR MIL

AHMR SFP IR MOA reticle has an illuminated 20 moa center with a 2 moa center cross and 2 moa incremental hash marks which provide a unique two layer visual reference for a shooter to locate and get dead on the target within a blink of an eye. The illuminated reticle provides excellent low light visibility. The unique design of the markings with 2 & 4 moa and 6 & 8 moa locating at the opposite side of the lines gives you a clear reading of the markings with no confusions.

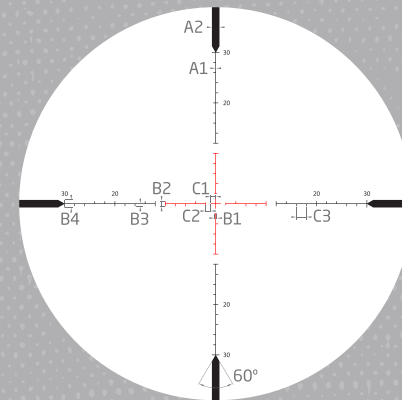

AHMR SFP IR MOA

APMR1 SFP IR MIL reticle is designed to maximize your performance on mid-distance shooting with illuminated center cross and 0.5 mil hash marks which provides excellent low light visibility. The illuminated 4 mil span center cross with 0.5 mil hash mark and extended 5 mil marks provide an unique two layer visual reference for a shooter quickly locate the target and find a holdover position.

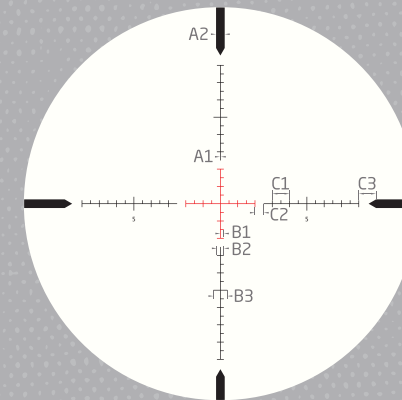

APMR1 SFP IR MIL

APLR1 SFP IR MIL reticle is designed for precision long-distance shooting with accurate ranging capability and helps you quickly determine distance, holdover positions, windage corrections and leads for a moving target. Having .2 & .4 mil and .6 & .8 mil on different side of cross lines helps a shooter quickly locate a holdover position with no confusion. The illuminated fine reticle provides excellent low light visibility and windage holdovers on the bullet droplines all the way up to 9 mils with .2 mil marks incremental in between.

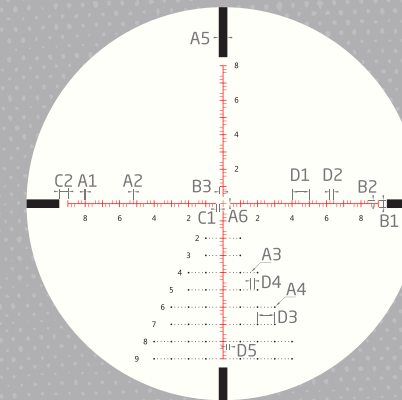

APLR1 SFP IR MIL

RIFLESCOPE DIMENSIONS

RIFLESCOPE MODEL	L1	L2	L3	L4	L5	L6	D1	D2
1-6x24 SFP	10.6	/	7	3.7	2.3	3.5	1.7	1.2
2.5-15x50 SFP	13.8	4.8	5.5	3.5	2	2.4	1.8	2.3
4.5-27x50 SFP	13.9	4.9	5.5	3.5	2	2.4	1.8	2.3

** dimensions are given in inches

RETICLE SUBTENSIONS

RETICLE	A1	A2	B1	B2	B3	B4	C1	C2	C3	C4	D1	D2	E			
ATSR16 SFP IR MOA	.4	1.38	1	2	3	4	2	2	2	5	20	18.5	5			
ATSR1 SFP IR MOA	.5	1.5	1.5	2	2.5	4	.45	1.5	2.95	2.5	15	2.4	5.6	9.5	14.6	35
ATSR16 SFP IR MIL	.12	1	.3	.6	1	2	.25	2	.25	5						
AHMR SFP IR MOA	.12	1.5	.5	1	.5	1.5	1	1	2	.2	.5	1	.2	1	.2	.2
APMR1 SFP IR MIL	.04	.5	.2	.4	.8	1	.5	1								
APLR1 SFP IR MIL	.04	.025	.05	.1	0.5	.025	.1	.2	.2	.2	.5	1	.2	1	.2	.2

* Reticle subtension valid @6x, 15x

DETAILED SPECS

POWER X OBJECTIVE LENS	TURRET STYLE	TUBE SIZE	AVAILABLE RETICLES	SURFACE FINISH	EYE RELIEF	FOV @100 YARDS	WEIGHT	LENGTH	CLICK VALUE	ADJ. RANGE PER ROTATION	TOTAL ELEV. ADJ.	TOTAL WINDAGE ADJ.	PARALLAX ADJ.	PURGING MATERIAL
1-6X24 SFP	CAPPED	30mm	ATSR16 SFP IR MOA	MATTE	3.8"	108-17.6 ft	18.1 oz	10.6"	0.5 MOA	30 MOA	150 MOA	150 MOA	FIXED 100 yds	ARGON
			ATSR16 SFP IR MIL						0.2 MIL	12 MIL	40 MIL	40 MIL		
2.5-15X50 SFP	EXPOSED	30mm	AHMR SFP IR MOA	MATTE	3.9"	41.8-6.8 ft	26 oz	13.8"	0.25 MOA	15 MOA	60 MOA	60 MOA	SIDE FOCUS 10yds - ∞	ARGON
			APMR1 SFP IR MIL						0.1 MIL	6 MIL	18MIL	18 MIL		
4.5-27X50 SFP	EXPOSED	30mm	AHMR SFP IR MOA	MATTE	3.9"	22.7-3.6 ft	26 oz	13.9"	0.25 MOA	15 MOA	60 MOA	60 MOA	SIDE FOCUS 30yds - ∞	ARGON
			APMR1 SFP IR MIL						0.1 MIL	6 MIL	18 MIL	18 MIL		
			APLR1 SFP IR MIL						0.1 MIL	6 MIL	18 MIL	18 MIL		



RIFLESCOPE HELOS^{BTR} **NEW**

The Helos BTR rifle scope family has landed. This first focal plane scope features locking turrets packaged with advanced fully-multi coated optics delivering you crystal clear bright images in any light scenario. Available in 6-24x50 and 8-34x56 configurations equipped with either MIL or MOA custom reticles, this family will deliver on the field and off the field when it comes to your bank account.

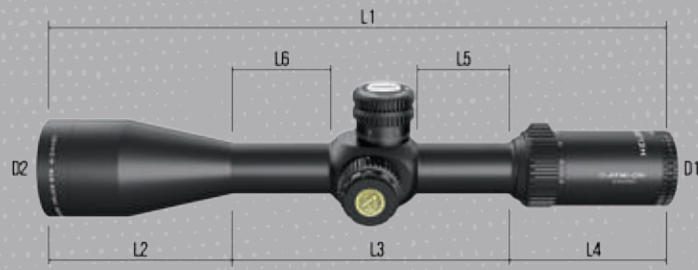

APLR3 FFP IR MOA reticle is illuminated all the way with 1 moa hash mark increments and drop lines in 5 moa increment on vertical direction down to 50 moa, both of which help you quickly lock in your target and set holdover positions. The reticle has a 2 moa span center cross with illuminated cross line extends to 40 moa on both vertical and horizontal direction. The unique design of having droplines going down to 40 moa with 5 moa between each drop line and 1 moa hash marks in between provide excellent holding over positions for long precision shooting.

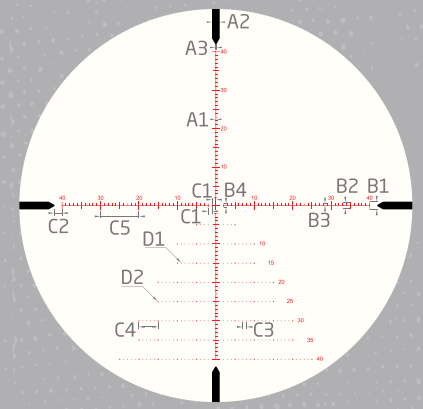

APLR2 FFP IR MOA

APMR FFP IR MIL reticle is designed to maximize your performance on long and mid-distance shooting with illuminated center cross and 0.5 mil hash mark, the APMR IR MIL reticle can help you quickly lock in your target and set holdover positions and leads for a moving target. The illuminated 18 mil span cross lines with 0.5 mil hash marks and 0.2 mil hash marks from 7 mil to 9 mil on three directions provide finer details that helps the shooter quickly locate the target and find a holdover position within higher level of precision and confidence.

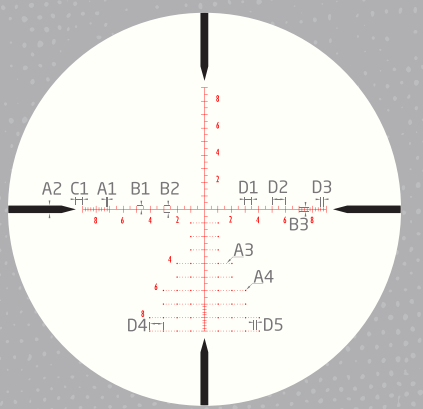

APMR FFP IR MIL

RIFLESCOPE DIMENSIONS

RIFLESCOPE MODEL	L1	L2	L3	L4	L5	L6	D1	D2
6-24x50 FFP	14.0	4.1	6.2	3.7	2	2.1	1.8	2.2
8-34x56 FFP	15.5	4.9	6.9	3.7	2	2.9	1.8	2.5

** dimensions are given in inches

RETICLE SUBTENSIONS

APLR2 FFP IR MOA	A1	A2	A3	B1	B2	B3	B4	C1	C2	C3	C4	C5	D1	D2
SUBTENSIONS IN MOA	.14	2	.3	2	1.5	.5	1	1	2	1	5	10	.2	.3
APMR FFP IR MIL	A1	A2	A3	A4	B1	B2	B3	C1	D1	D2	D3	D4	D5	
SUBTENSIONS IN MIL	.02	.4	.05	.1	.2	.4	.3	2	.5	1	.2	1	2	

DETAILED SPECS

POWER X OBJECTIVE LENS	TURRET STYLE	TUBE SIZE	AVAILABLE RETICLES	SURFACE FINISH	EYE RELIEF	FOV @100 YARDS	WEIGHT	LENGTH	CLICK VALUE	ADJ. RANGE PER ROTATION	TOTAL ELEV. ADJ.	TOTAL WINDAGE ADJ.	PARALLAX ADJ.	PURGING MATERIAL
6-24X50 FFP	EXPOSED	30mm	APLR2 FFP IR MOA	MATTE	3.3"	16.7-4.5 ft	29.7 oz	14.0"	0.25 MOA	15 MOA	60 MOA	60 MOA	SIDE FOCUS 10yds - ∞	ARGON
			APMR FFP IR MIL						0.1 MIL	6 MIL	18 MIL	18 MIL		
8-34X56 FFP	EXPOSED	30 mm	APLR2 FFP IR MOA	MATTE	3.3"	12.5-3 ft	32.3 oz	15.5"	0.25 MOA	15 MOA	50 MOA	50 MOA	SIDE FOCUS 15yds - ∞	ARGON
			APMR FFP IR MIL						0.1 MIL	6 MIL	13 MIL	13 MIL		

8X

APLR2 FFP IR MOA

34X

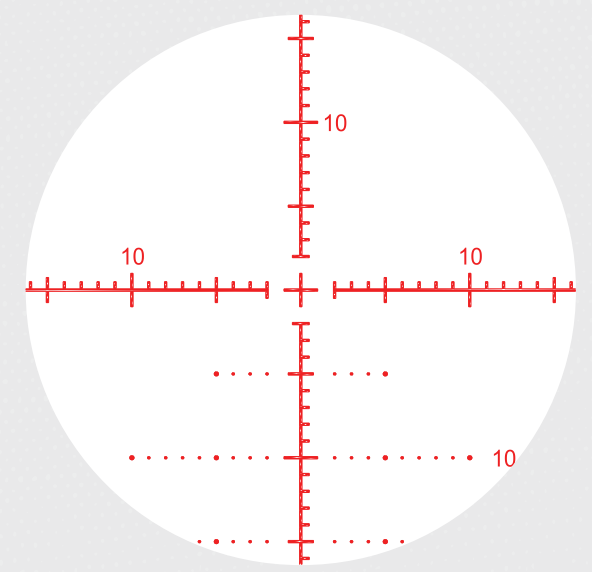
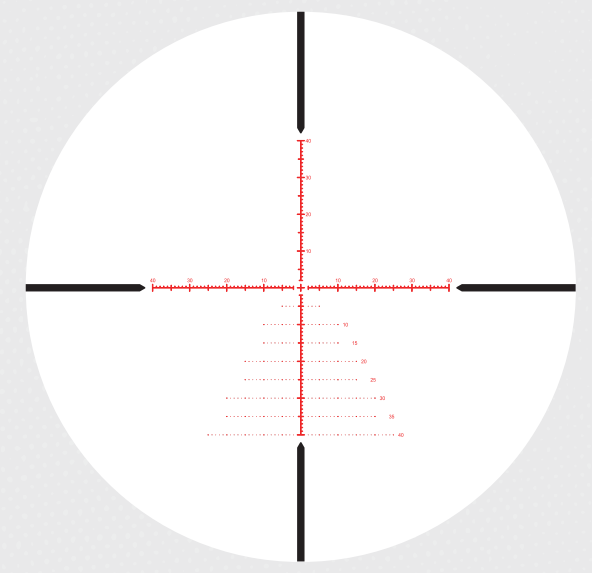

8X

APMR FFP IR MIL

34X

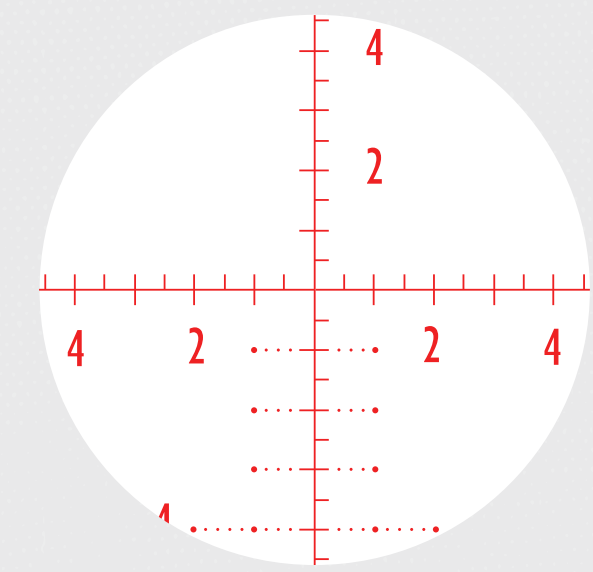
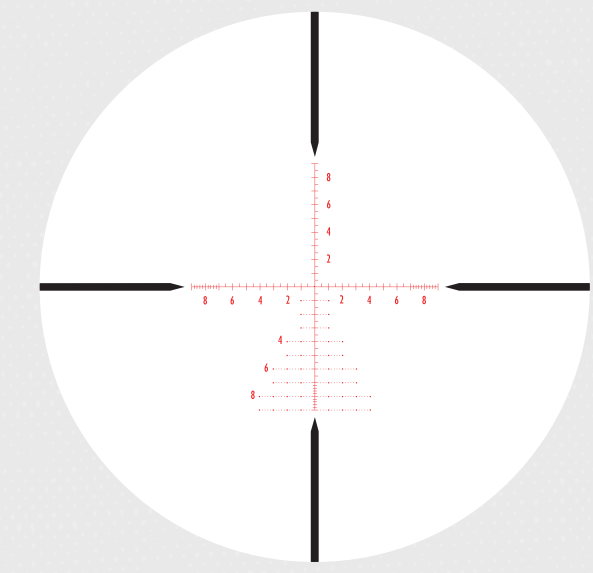



RIFLESCOPE ARGOS^{BTR}

The Argos BTR rifle scope is reporting for duty. This first focal plane scope gives you easy elevation and windage adjustments, packaged with the advanced Fully-Multi Coated Optics deliver crystal clear bright images in any light scenario. Add the side parallax adjustments to the Argos scope which gives you the ability to adjust to any range right at your fingertips, gives you one heck of a rifle scope.

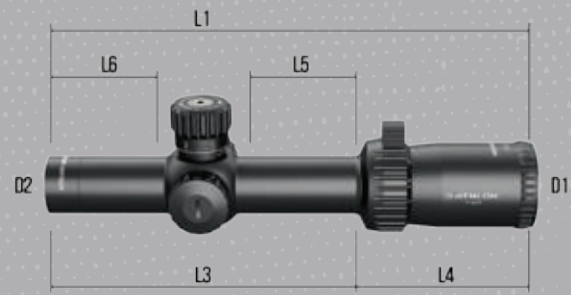

AHSR14 FFP IR MOA reticle has an illuminated 20 moa diameter circle with a 2 moa center cross and 2 moa incremental hash marks. The cross lines, middle circle, and center cross provide a unique three layer visual reference that draws shooters' vision right into the center. The illuminated portion of the reticle provides excellent low light visibility and accurate elevation holdovers all the way up to 30 moa with 2 moa marks incremental.

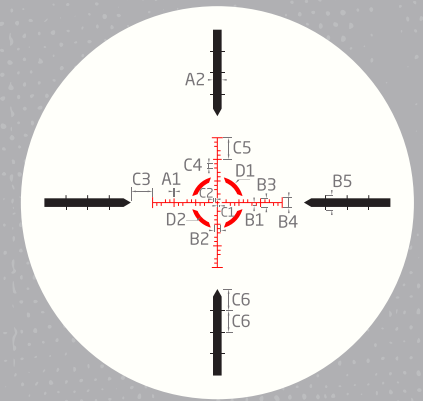

AHSR14 FFP IR MOA

AHSR 14 FFP IR MIL reticle is designed to maximize your performance on short and mid-range shooting with an illuminated 16 mil diameter circle, 1 mil center cross, and cross lines with 1mil hash mark incremental extended to 8 mils on both horizontal and vertical directions. The reticle at 1x becomes a red dot circle for short range target, while it offers enough details at 4x to help shooters quickly spot their target and set holdover positions.

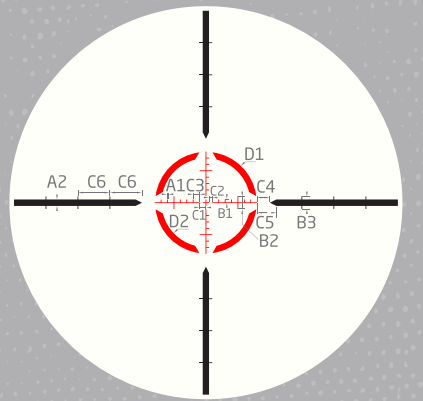

AHSR14 FFP IR MIL

RIFLESCOPE DIMENSIONS

RIFLESCOPE MODEL	L1	L2	L3	L4	L5	L6	D1	D2
1-4x24 FFP	9.8	/	6.2	3.6	2.3	2.4	1.8	1.2

** dimensions are given in inches

RETICLE SUBTENSIONS

AHSR14 FFP IR MOA	A1	A2	B1	B2	B3	B4	B5	C1	C2	C3	C4	C5	C6	D1	D2
SUBTENSIONS IN MOA	.5	4	1.5	3	4	5	7	1	1	10	2	10	10	12	10
AHSR14 FFP IR MIL	A1	A2	B1	B2	B3	C1	C2	C3	C4	C5	C6	D1	D2		
SUBTENSIONS IN MIL	.13	1	.5	2	2	.5	.5	1	2	3	5	8	7		

DETAILED SPECS

POWER X OBJECTIVE LENS	TURRET STYLE	TUBE SIZE	AVAILABLE RETICLES	SURFACE FINISH	EYE RELIEF	FOV @100 YARDS	WEIGHT	LENGTH	CLICK VALUE	ADJ. RANGE PER ROTATION	TOTAL ELEV. ADJ.	TOTAL WINDAGE ADJ.	PARALLAX ADJ.	PURGING MATERIAL
1-4x24 FFP	EXPOSED	30mm	AHSR14 FFP IR MOA AHSR14 FFP IR MIL	MATTE	3.5"	112-27 ft	20.5 oz	9.8"	0.5 MOA 0.2 MIL	30 MOA 12 MIL	120 MOA 40 MIL	120 MOA 40 MIL	FIXED 100 yds	ARGON

AHSR14 FFP IR MOA 1X 4X

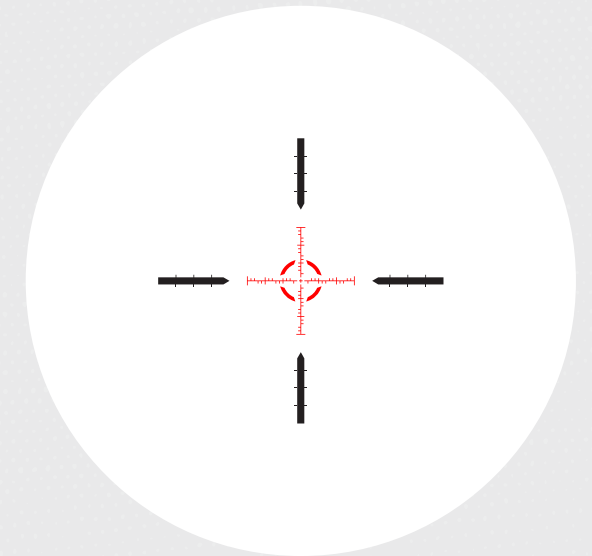
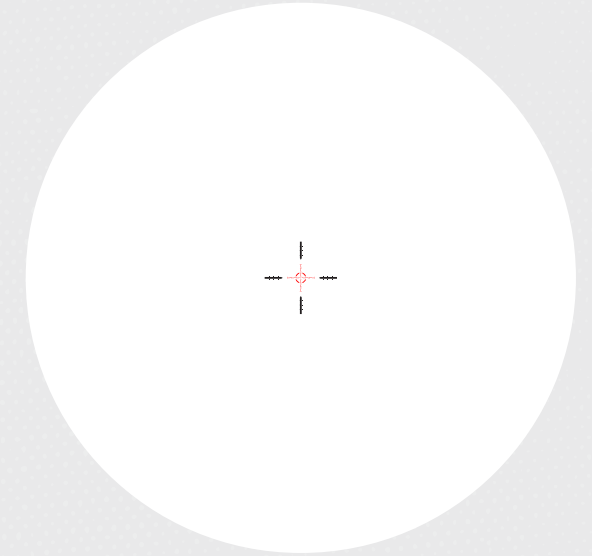

AHSR14 FFP IR MIL 1X 4X

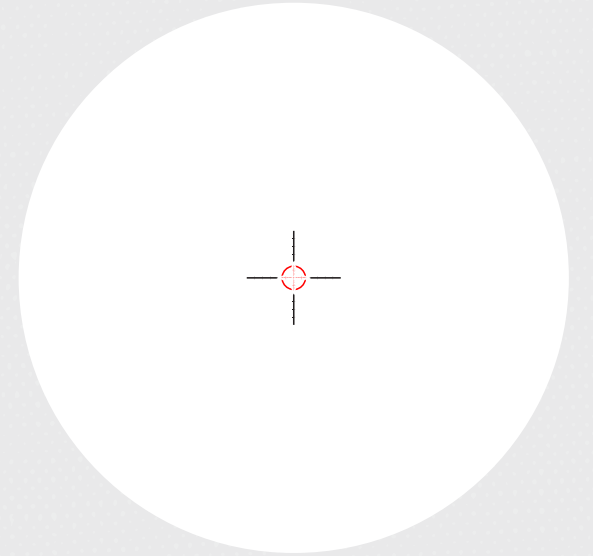



RIFLESCOPE ARGOS^{BTR}

The Argos BTR rifle scope is reporting for duty. This first focal plane scope gives you easy elevation and windage adjustments, packaged with the advanced Fully-Multi Coated Optics deliver crystal clear bright images in any light scenario. Add the side parallax adjustments to the Argos scope which gives you the ability to adjust to any range right at your fingertips, gives you one heck of a rifle scope.

ATMR FFP IR MOA reticle has a large illuminated center and 2 moa incremental hash marks, which help you quickly lock in your target and set holdover positions. The illuminated portion has a 2 moa center cross with illuminated vertical cross line extends to 40 moa and all the way to 90 moa on black line with 10 moa incremental markings and the illuminated horizontal cross line extended to 30 moa at each direction. The illuminated reticle provides excellent low light visibility and accurate elevation holdovers all the way up to 40 moa with 2 moa markings incremental.

APMR FFP IR MIL reticle is designed to maximize your performance on long and mid-distance shooting with illuminated center cross and 0.5 mil hash mark, the APMR IR MIL reticle can help you quickly lock in your target and set holdover positions and leads for a moving target. The illuminated 18 mil span cross lines with 0.5 mil hash marks and 0.2 mil hash marks from 7 mil to 9 mil on three directions provide finer details that helps the shooter quickly locate the target and find a holdover position within higher level of precision and confidence.

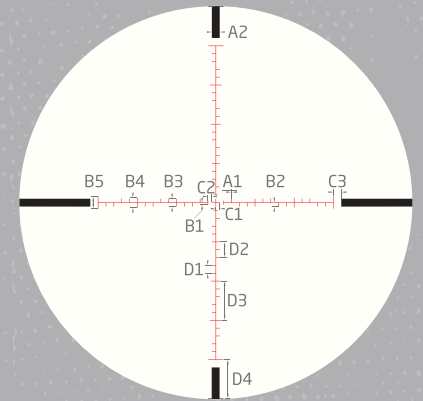
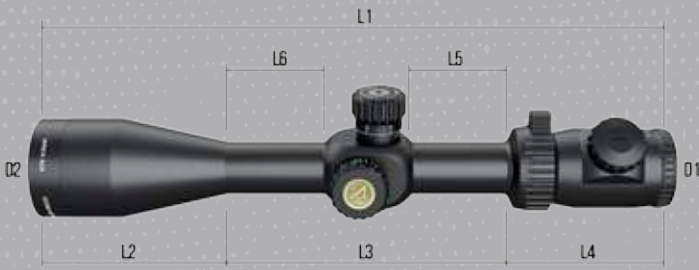

ATMR FFP IR MOA

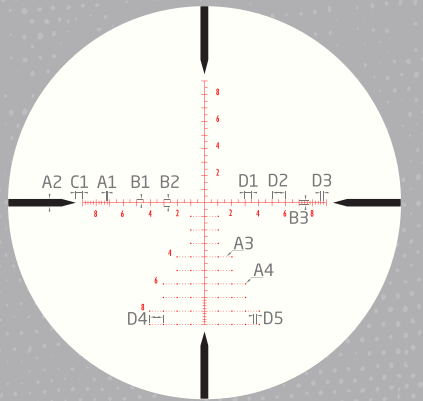

APMR FFP IR MIL

RIFLESCOPE DIMENSIONS

RIFLESCOPE MODEL	L1	L2	L3	L4	L5	L6	D1	D2
6-24x50 FFP	14.1	4.2	6.2	3.7	2	2.1	1.8	2.2
8-34x56 FFP	15.5	4.9	6.9	3.7	2	2.9	1.8	2.5

** dimensions are given in inches

RETICLE SUBTENSIONS

	A1	A2	B1	B2	B3	B4	B5	C1	C2	C3	D1	D2	D3	D4
ATMR FFP IR MOA SUBTENSIONS IN MOA	.14	2	1	1	2	25	4	1	1	2	2	4	10	10
	A1	A2	A3	A4	B1	B2	B3	C1	D1	D2	D3	D4	D5	
APMR FFP IR MIL SUBTENSIONS IN MIL	.02	.4	.05	.1	.2	.4	.3	2	.5	1	.2	1	2	

DETAILED SPECS

POWER X OBJECTIVE LENS	TURRET STYLE	TUBE SIZE	AVAILABLE RETICLES	SURFACE FINISH	EYE RELIEF	FOV @100 YARDS	WEIGHT	LENGTH	CLICK VALUE	ADJ. RANGE PER ROTATION	TOTAL ELEV. ADJ.	TOTAL WINDAGE ADJ.	PARALLAX ADJ.	PURGING MATERIAL
6-24x50 FFP	EXPOSED	30mm	ATMR FFP IR MOA	MATTE	3.3"	16.7-4.5 ft	29.6 oz	14.1"	0.25MOA	12 MOA	60 MOA	60 MOA	SIDE FOCUS 10yds - ∞	ARGON
			APMR FFP IR MIL						0.1 MIL	5 MIL	18 MIL	18 MIL		
8-34x56 FFP	EXPOSED	30mm	ATMR FFP IR MOA	MATTE	3.3"	12.5-3 ft	32.2 oz	15.5"	0.25 MOA	12 MOA	45 MOA	45 MOA	SIDE FOCUS 15yds - ∞	ARGON
			APMR FFP IR MIL						0.1 MIL	5 MIL	13 MIL	13 MIL		

6X

ATMR FFP IR MOA

24X

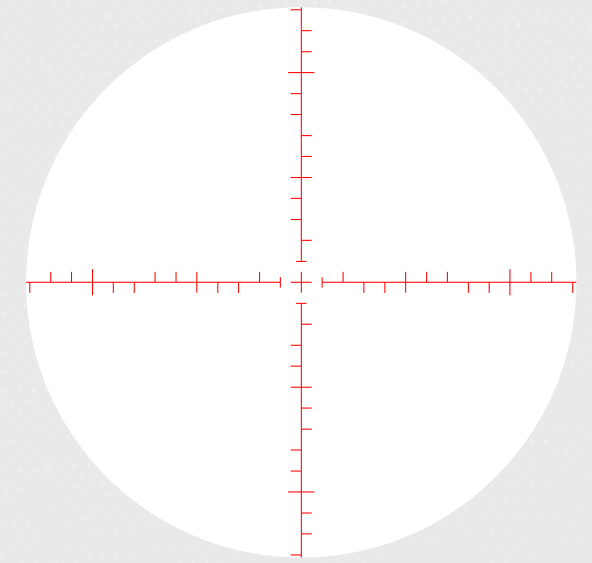
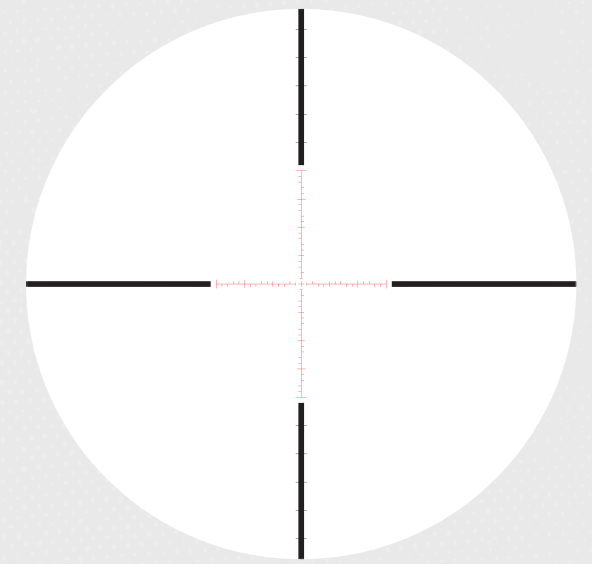

6X

APMR FFP IR MIL

24X

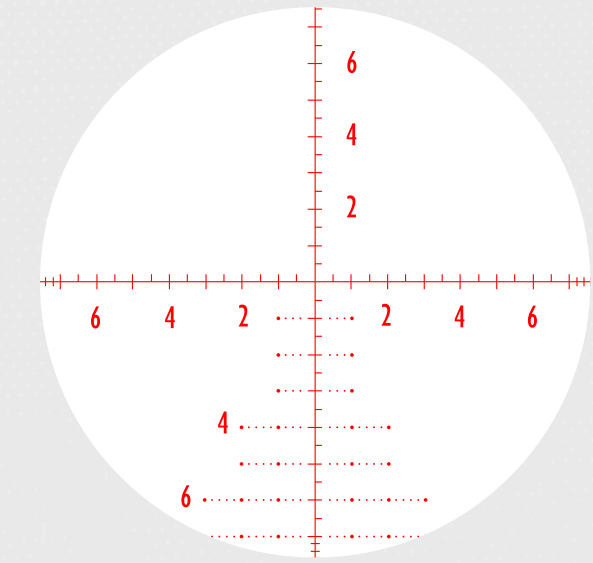
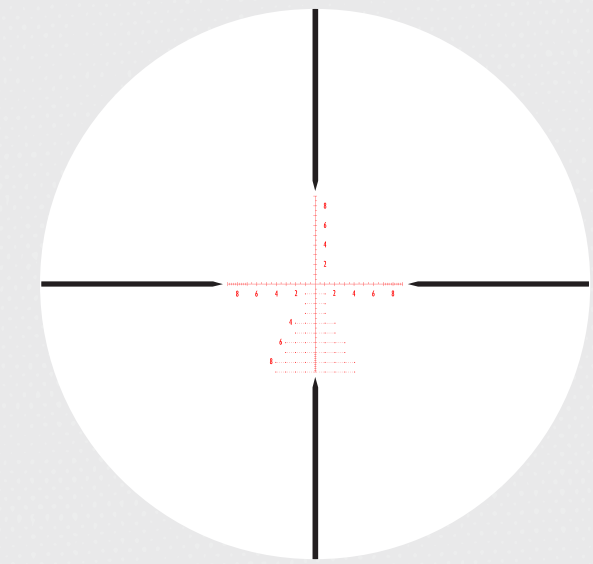



RIFLESCOPE ARGOS

The Argos family of scopes is designed for the serious big game hunter. The 5x magnification makes this scope versatile in multiple shooting disciplines from up close targets to long range distances. The fully multicoated optics are protected by the 6061T6 aircraft grade aluminum tube making this scope virtually indestructible. Oh yea, add in our XPL coatings and argon purged, rain, snow or shine, you can count on this scope to perform!

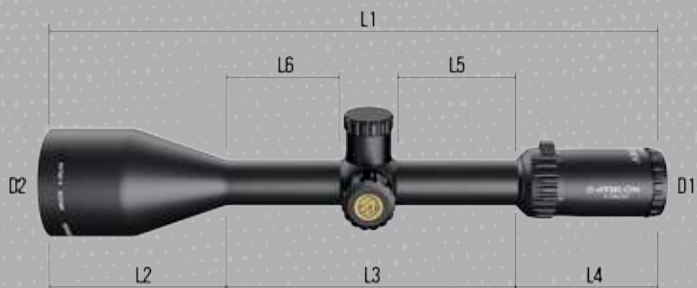

Center X Reticle is a perfect choice for shooters wishing to have a clear field of view with a more traditional crosshair. The Center X reticle allows shooters to quickly view their target while maintaining one distinct aiming point on their reticle. The heavy posts stand out nicely against cover and in twilight conditions, pointing boldly to the intersection.

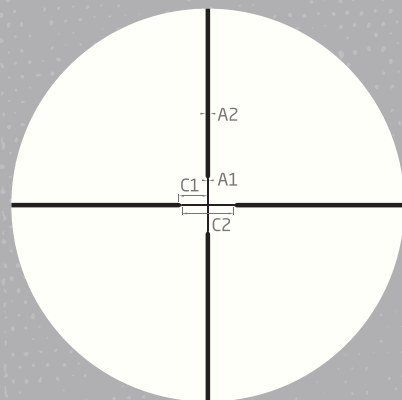

CENTER X

AHMR1 SFP MOA reticle is perfect for hunting and shooting at varying ranges out in the field. The customized Mil hash mark design helps to eliminate any guesswork with hold-over and windage adjustments. Bottom line, when you need to depend on the shot, this reticle will deliver.

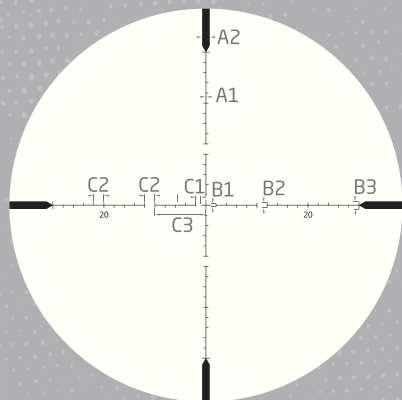

AHMR1 SFP MOA

BDC 600 reticle can be used effectively with a variety of firearms giving your accurate ranges and reference marks which can be used to compensate for bullet drift in windy conditions or range distances. The user can sight in at 100 yards on any magnification setting, but for the ballistic reticle feature to function properly, the scope's magnification must be set to the correct power as follows: 2-10x40 (10x power), and for 3-15x40, 4-20x50 and 6-30x56 (15x power)

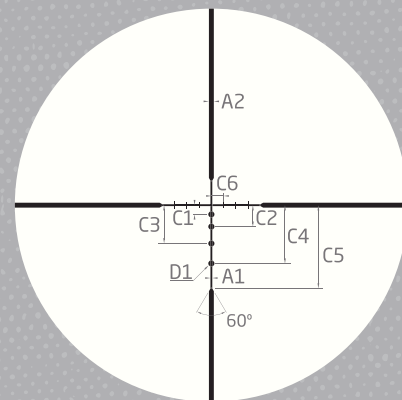

BDC 600

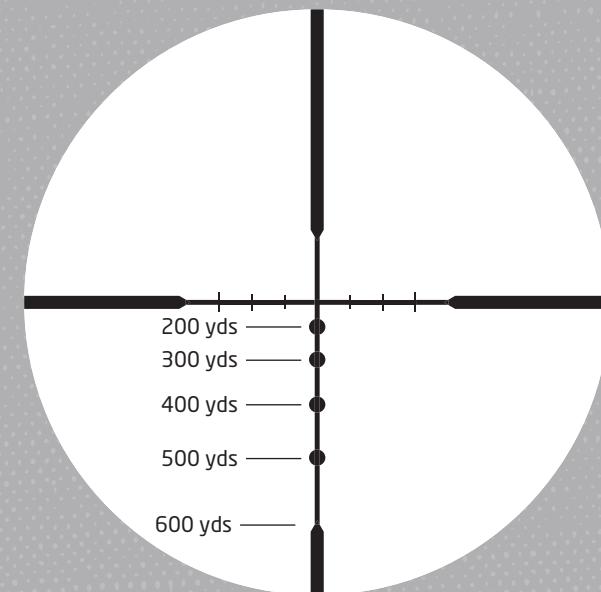

The **BDC 600** will work with any of the following ammunition loads:

- .223 Win 55 gr
- .243 Win, 95 gr
- 25-06 Rem 115 gr
- .270 Win, 130 gr
- .270 WSM, 150 gr
- .7mm Rem Mag, 150 gr
- .7mm WSM, 150 gr
- .30-06 Sprg, 150 gr
- .300 Winchester Mag, 180 gr
- 300 WSM, 180 gr
- .308 Win 150 gr
- .338 Win, 200 gr

RIFLESCOPE DIMENSIONS

RIFLESCOPE MODEL	L1	L2	L3	L4	L5	L6	D1	D2
2-10x40 SFP	12.2	3.1	6.0	3.1	2.6	2.1	1.5	1.9
3-15x40 SFP	12.2	3.1	6.0	3.1	2.6	2.1	1.5	1.9
4-20x50 SFP	13.1	3.9	6.1	3.1	2.6	2.4	1.5	2.4
6-30x56 SFP	14.7	4.9	6.8	3	2.6	2.8	1.5	2.6

** dimensions are given in inches

RETICLE SUBTENSIONS

RETICLE	A1	A2	C1	C2	CONFIGURATION					
CENTER X	.21	.63	4.55	9.1	2-10x40					
CENTER X	.14	.42	3.05	6.1	3-15x40					
BDC 600	A1	A2	C1	C2	C3	C4	C5	C6	D1	CONFIGURATION
BDC 600	.3	.8	1.5	3.5	6.25	9.5	13.6	2	1	4-20x50
AHMR1 SFP MOA	A1	A2	C1	C2	C3	B1	B2	B3	CONFIGURATION	
AHMR1 SFP MOA	.13	1.5	1	2	10	.5	1	1.5	4-20x50	
AHMR1 SFP MOA	A1	A2	C1	C2	C3	B1	B2	B3	CONFIGURATION	
AHMR1 SFP MOA	.1	1.2	1	2	10	.5	1	1.5	6-30x56	

* Reticle subtension valid @10x, 15x

DETAILED SPECS

POWER X OBJECTIVE LENS	TURRET STYLE	TUBE SIZE	AVAILABLE RETICLES	SURFACE FINISH	EYE RELIEF	FOV @100 YARDS	WEIGHT	LENGTH	CLICK VALUE	ADJ. RANGE PER ROTATION	TOTAL ELEV. ADJ.	TOTAL WINDAGE ADJ.	PARALLAX ADJ.	PURGING MATERIAL
2-10x40 SFP	CAPPED	1"	CENTER X BDC 600	MATTE	>3.8"	48.8-9.8 ft	15.5 oz	12.2"	0.25 MOA	15 MOA	60 MOA	60 MOA	FIXED 100 yds	ARGON
3-15x40 SFP	CAPPED	1"	CENTER X BDC 600	MATTE	>3.8"	30.4-6.3 ft	16.5 oz	12.2"	0.25 MOA	15 MOA	60 MOA	60 MOA	FIXED 100 yds	ARGON
4-20x50 SFP	CAPPED	1"	BDC 600 AHMR1 SFP MOA	MATTE	>3.8"	23.6-4.7 ft	19.5 oz	13.1"	0.25 MOA	15 MOA	50 MOA	50 MOA	SIDE FOCUS 25yds - ∞	ARGON
6-30x56 SFP	CAPPED	30mm	BDC 600 AHMR1 SFP MOA	MATTE	>3.8"	16.6-5.4 ft	22 oz	14.7"	0.25 MOA	15 MOA	60 MOA	60 MOA	SIDE FOCUS 25yds - ∞	ARGON



RIFLESCOPE TALOS^{BTR}

Let's face it, dawn or dusk are when more tags are filled during low-light situations. The Talos BTR was designed to tackle this problem with our advanced multi-coated lenses for clarity and brightness when you are running out of light. The 4x magnification range will give you great versatility for taking that close shot in dense trees or that long shot in the open ranges.

AHSR 14 SFP IR MIL reticle is designed to maximize your performance on short range shooting with illuminated 1 mil center cross and 1 mil hash marks increments extended to 8 mils on both horizontal and vertical directions and can help you quickly spot your target and set holdover positions and leads for a moving target. The illuminated 16 mil center with an 1 mil center cross (0.5 mil from center to the side) and 10 mil black lines enable a shooter to quickly locate the target and put it right on the center cross within a blink of an eye. The illuminated portion of the reticle provides excellent low light visibility.

APLR2 FFP IR MIL reticle is designed to maximize your performance on precision long and mid range shooting with accurate ranging capability. It will help you quickly determine distance, holdover positions, windage correction and leads for a moving target. The unique design of fine .2 mil hash mark, having .2 and .4 on one side of either horizontal or vertical line and .6 and .8 on another side, helps the shooter quickly locate a holdover position with .2 mil increments within a blink of an eye. The illuminated fine reticle provides excellent low light visibility and windage holdovers on the bullet droplines all the way up to 9 mils with .2 mil marks increments between.

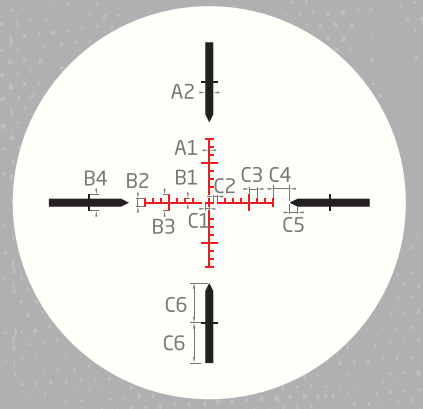
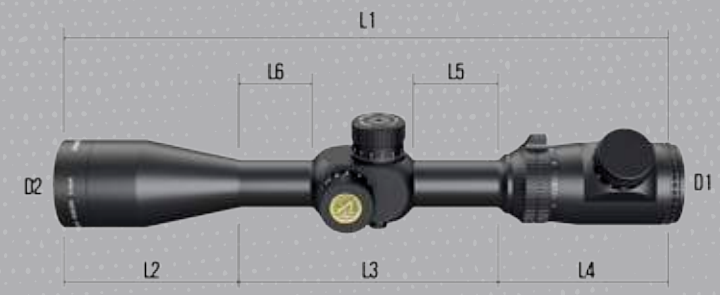

AHSR14 SFP IR MIL

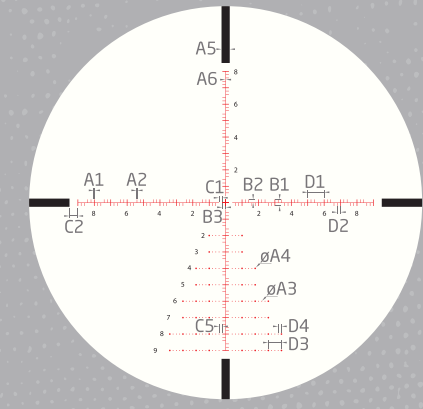

APLR2 FFP IR MIL

4X

APLR2 FFP IR MIL

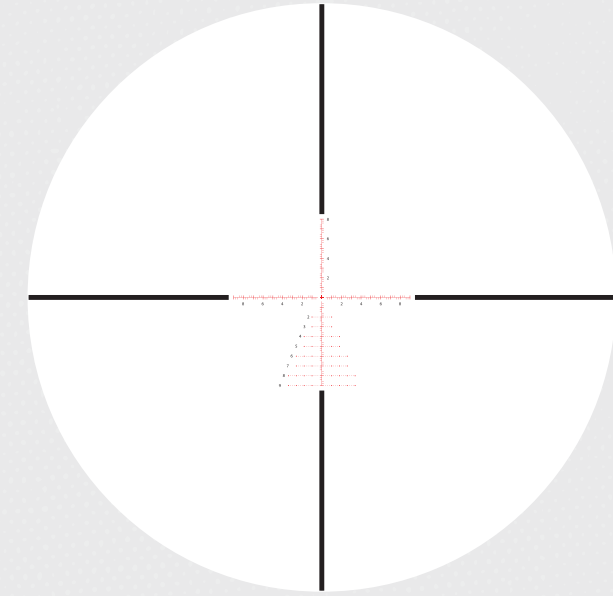

APLR2 FFP IR MIL

14X

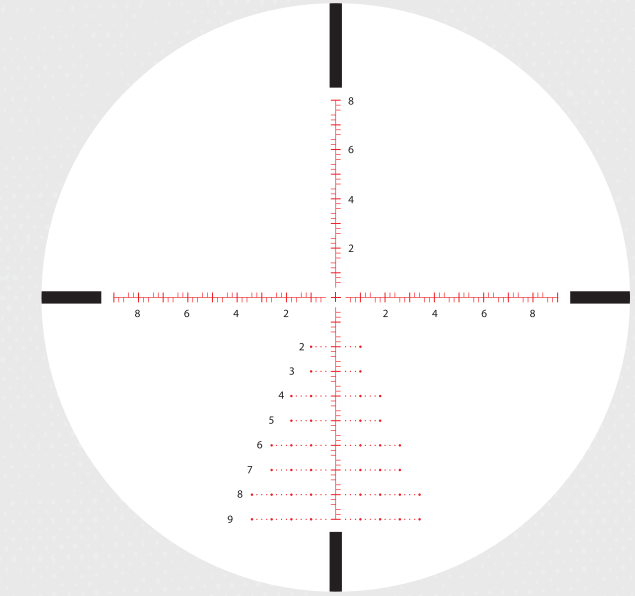

RIFLESCOPE DIMENSIONS

RIFLESCOPE MODEL	L1	L2	L3	L4	L5	L6	D1	D2
1-4X24 SFP	9.2	/	5.6	3.6	1.9	2.6	1.8	1.2
4-14X44 FFP	12.9	3.9	5.0	4.0	1.4	2.0	1.7	2.0

** dimensions are given in inches

RETICLE SUBTENSIONS

AHSR14 SFP IR MIL	A1	A2	B1	B2	B3	B4	C1	C2	C3	C4	C5	C6				
SUBTENSIONS IN MIL	.13	1	.5	1	2	2	.5	.5	1	2	1	5				
APLR2 FFP IR MIL	A1	A2	A3	A4	A5	A6	B1	B2	B3	C1	C2	D1	D2	D3	D4	D5
SUBTENSIONS IN MIL	.04	.025	.05	.1	.5	.025	.1	.2	.2	.2	.5	1	.2	1	.2	.2

DETAILED SPECS

POWER X OBJECTIVE LENS	TURRET STYLE	TUBE SIZE	AVAILABLE RETICLES	SURFACE FINISH	EYE RELIEF	FOV@100 YARDS	WEIGHT	LENGTH	CLICK VALUE	ADJ. RANGE PER ROTATION	TOTAL ELEV. ADJ.	TOTAL WINDAGE ADJ.	PARALLAX ADJ.	PURGING MATERIAL
1-4X24 SFP	EXPOSED	30mm	AHSR14 SFP IR MIL	MATTE	6.26-3.5"	110-26 ft	18 oz	9.2"	0.2 MIL	12 MIL	40 MIL	40 MIL	FIXED 100 Yds	NITROGEN
4-14X44 SFP	EXPOSED	30mm	APLR2 FFP IR MIL	MATTE	3.23-3.15"	27.2-7.9 ft	23.6 oz	12.9"	0.1 MIL	5 MIL	20 MIL	20 MIL	SIDE FOCUS 10yds - ∞	NITROGEN



RIFLESCOPE TALOS

Just like it's brother the Talos BTR product family, the Talos is loaded with the same key features. With 3 different configurations to choose from (3-12x40, 4-16x40, 6-24x50) and 4 reticle selections, the choice is very easy with this one. Performance, reliability, versatile all while not breaking the bank.



Center X Reticle is a perfect choice for shooters wishing to have a clear field of view with a more traditional crosshair. The Center X reticle allows shooters to quickly view their target while maintaining one distinct aiming point on their reticle. The heavy posts stand out nicely against cover and in twilight conditions, pointing boldly to the intersection.

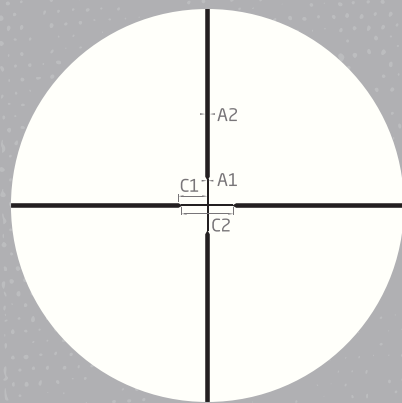

CENTER X

Mil Dot reticle is one of the most accurate, versatile means of estimating ranges using a manual optical device. The Mil Dot allows the user to do range estimations, holdover and wind drift compensation as well as for precise leads for moving targets.

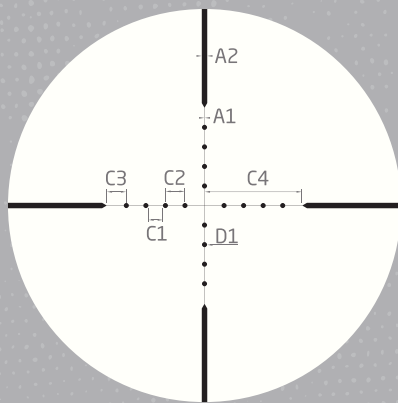

MILDOT

ATMR1 SFP IR MIL reticle is perfect for shooting at the range or competing in a competitions. The customized Mil hash mark design helps to eliminate any guesswork with holdover and windage adjustments. The illuminated reticle is great for low light situations when you need to count on a good, accurate shot.

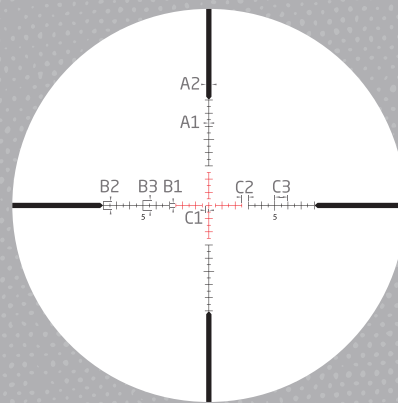

ATMR1 SFP IR MIL

BDC 600 IR was designed to deliver a high level of precision at extended targets that can be used with today's most popular rifle cartridges.

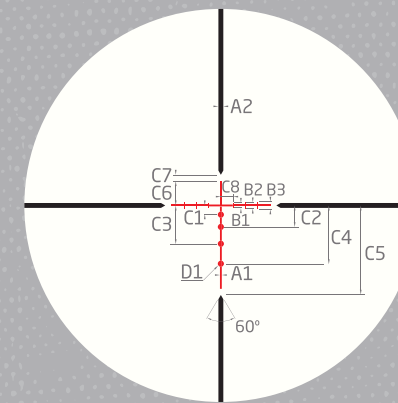

BDC 600 IR

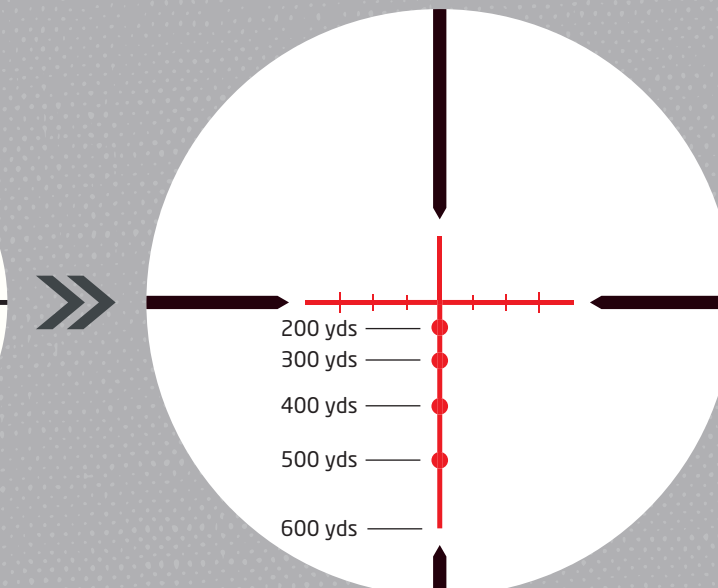

The **BDC 600 IR** will work with any of the following ammunition loads:

- .223 Win 55 gr
- .243 Win, 95 gr
- 25-06 Rem 115 gr
- .270 Win, 130 gr
- .270 WSM, 150 gr
- .7mm Rem Mag, 150 gr
- .7mm WSM, 150 gr
- .30-06 Sprg, 150 gr
- .300 Winchester Mag, 180 gr
- 300 WSM, 180 gr
- .308 Win 150 gr
- .338 Win, 200 gr

ATHLON OPTICS

RIFLESCOPE DIMENSIONS

RIFLESCOPE MODEL	L1	L2	L3	L4	L5	L6	D1	D2
3-12x40 SFP	12	3.6	4.8	3.7	1.9	1.3	1.8	1.9
4-16x40 SFP	12.9	3.5	5.8	3.7	1.9	2.2	1.8	1.9
6-24x50 SFP	13.9	4	6.2	3.7	1.9	2.7	1.8	2.2

** dimensions are given in inches

RETICLE SUBTENSIONS

RETICLE	A1	A2	C1	C2	CONFIGURATION									
CENTER X	A1	A2	C1	C2	3-12x40									
MILDOT	A1	A2	C1	C2	C3	C4	D1							
BDC 600 IR	A1	A2	B1	B2	B3	C1	C2	C3	C4	C5	C6	C7	C8	D1
ATMR1 SFP IR MIL	A1	A2	B1	B2	B3	C1	C2	C3						

SUBTENSIONS IN MOA

SUBTENSIONS IN MIL

DETAILED SPECS

POWER X OBJECTIVE LENS	TURRET STYLE	TUBE SIZE	AVAILABLE RETICLES	SURFACE FINISH	EYE RELIEF	FOV @100 YARDS	WEIGHT	LENGTH	CLICK VALUE	ADJ. RANGE PER ROTATION	TOTAL ELEV. ADJ.	TOTAL WINDAGE ADJ.	PARALLAX ADJ.	PURGING MATERIAL
3-12X40 SFP	CAPPED	1"	CENTER X	MATTE	3.82-3.35"	34.1-8.9 ft	16.2 oz	12"	0.25 MOA	15 MOA	60 MOA	60 MOA	SIDE FOCUS 10yds - ∞	NITROGEN
			BDC 600 IR						0.1 MIL	5 MIL	20 MIL	20 MIL		
			MILDOT						0.25 MOA	15 MOA	60 MOA	60 MOA		
4-16X40 SFP	CAPPED	1"	BDC 600 IR	MATTE	3.8-3.35"	24.1-6.3 ft	19.1 oz	12.9"	0.25 MOA	15 MOA	60 MOA	60 MOA	SIDE FOCUS 15yds - ∞	NITROGEN
			MILDOT						0.1 MIL	5 MIL	20 MIL	20 MIL		
6-24X50 SFP	CAPPED	1"	BDC 600 IR	MATTE	3.11-3.03"	16.8-4.5 ft	23 oz	13.9"	0.25 MOA	15 MOA	50 MOA	50 MOA	SIDE FOCUS 10yds - ∞	NITROGEN
			ATMR1 SFP IR MIL						0.1 MIL	5 MIL	18 MIL	18 MIL		

* Reticle subtensions valid @12x, 16x, 18x
* Mildot reticle subtensions valid @10x



RIFLESCOPE NEOS

The Neos family is the perfect scope for those who want quality and lots of features, all while staying on a budget. Fully multicoated optics protected in a heat treated one piece aluminum tube, nitrogen purged to give you a waterproof, fog proof and shockproof scope. Rugged, precise, dependable, reliable, need we say more.....



Center X reticle is a perfect choice for shooters wishing to have a clear field of view with a more traditional crosshair. The Center X reticle allows shooters to quickly view their target while maintaining one distinct aiming point on their reticle. The heavy posts stand out nicely against cover and in twilight conditions, pointing boldly to the intersection.

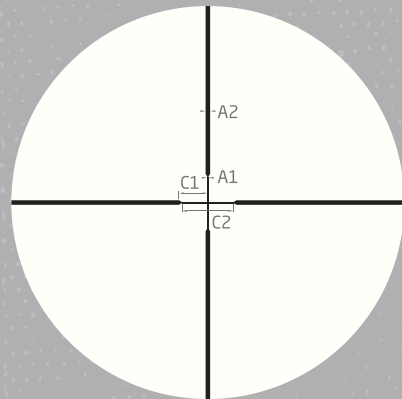

CENTER X

BDC22 Rim Fire reticle was designed specifically for rimfire. This reticle allows shooters to compensate for bullet drop at extended shooting distances. When using a .22 LR with a muzzle velocity of approximately 1,250 feet per second, this reticle is designed to be zeroed at 50 yards, providing bullet drop compensation for 75, 100, 125 and 150 yards.

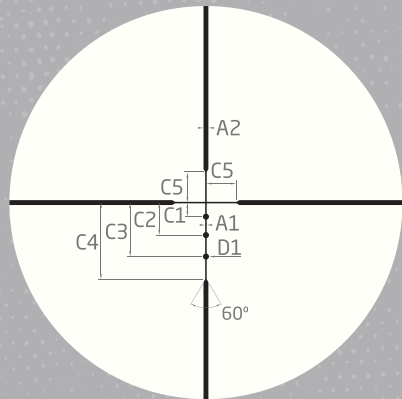

BDC 22 RIMFIRE

BDC 500 IR was designed to deliver a high level of precision at extended targets that can be used with today's most popular rifle cartridges.

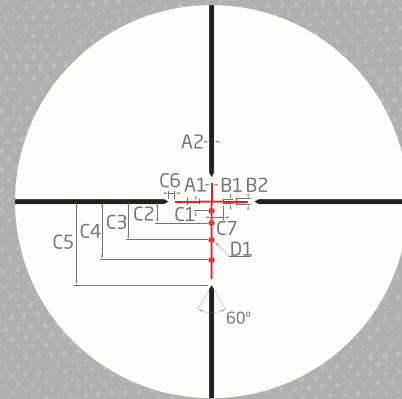

BDC 500 IR

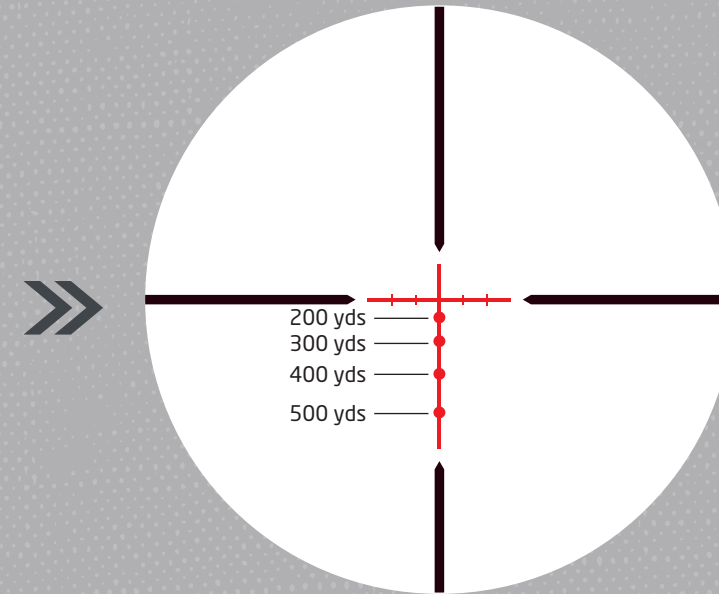

The **BDC 500 IR** will work with any of the following ammunition loads:

- .223 Win 55 gr
- .243 Win, 95 gr
- 25-06 Rem 115 gr
- .270 Win, 130 gr
- .270 WSM, 150 gr
- .7mm Rem Mag, 150 gr
- .7mm WSM, 150 gr
- .30-06 Sprg, 150 gr
- .300 Winchester Mag, 180 gr
- 300 WSM, 180 gr
- .308 Win 150 gr
- .338 Win, 200 gr

Neos rifle scope internal dials:



ATHLON OPTICS

RIFLESCOPE DIMENSIONS

RIFLESCOPE MODEL	L1	L2	L3	L4	L5	L6	D1	D2
3-9x40 SFP	12.4	3.3	5.6	3.5	2.3	2.3	1.6	1.9
4-12X40 SFP	12.4	3.3	5.6	3.5	2.3	2.3	1.6	1.9
6-18X44 SFP	13.5	3.7	6.3	3.5	2.3	3	1.6	2

** dimensions are given in inches

RETICLE SUBTENSIONS

RETICLE	A1	A2	C1	C2	CONFIGURATION							
CENTER X	.25	.9	6.5	13	3-9x40							
CENTER X	.18	.7	4.5	9	4-12x40							
CENTER X	.12	.5	3.2	6.5	6-18x44							
BDC 22 RIMFIRE	A1	A2	C1	C2	C3	C4	C5	D1				
SUBTENSIONS IN MOA	.25	.8	2.3	5.3	8.8	125	5	1				
BDC 500 IR	A1	A2	B1	B2	C1	C2	C3	C4	C5	C6	C7	D1
SUBTENSIONS IN MOA	.3	.8	.8	1	1.5	35	6.25	9.5	13.6	1	2	1

* Reticle subtension valid @9x, 12x and 18x

DETAILED SPECS

POWER X OBJECTIVE LENS	TURRET STYLE	TUBE SIZE	AVAILABLE RETICLES	SURFACE FINISH	EYE RELIEF	FOV @100 YARDS	WEIGHT	LENGTH	CLICK VALUE	ADJ. RANGE PER ROTATION	TOTAL ELEV. ADJ.	TOTAL WINDAGE ADJ.	PARALLAX ADJ.	PURGING MATERIAL
3-9X40 SFP	CAPPED	1"	CENTER X	MATTE	2.99-3.07"	37.8-12.6 ft	17 oz	12.4"	0.25 MOA	15 MOA	80 MOA	80 MOA	FIXED 100 yds	NITROGEN
			BDC 500 IR											
			BDC 22 RIMFIRE											
4-12X40 SFP	CAPPED	1"	CENTER X	MATTE	3.11-3.15"	27.3-8.9 ft	18.1 oz	12.4"	0.25 MOA	15 MOA	60 MOA	60 MOA	SIDE FOCUS 10yds - ∞	NITROGEN
			BDC 500 IR											
6-18X44 SFP	CAPPED	1"	CENTER X	MATTE	3.39-3.19"	17.5-5.9 ft	21.7 oz	13.5"	0.25 MOA	15 MOA	50 MOA	50 MOA	SIDE FOCUS 10yds - ∞	NITROGEN
			BDC 500 IR											



RED DOT SIGHTS MIDAS^{BTR}

When you need fast, effective, accurate, simple and reliable Athlon Optics Red Dot family of products is just what you need. The Red Dot offers a bright red light for easy vision in all lighting situations. When the stakes are at their highest, whatever your needs are, trust your shot with Athlon Optics.

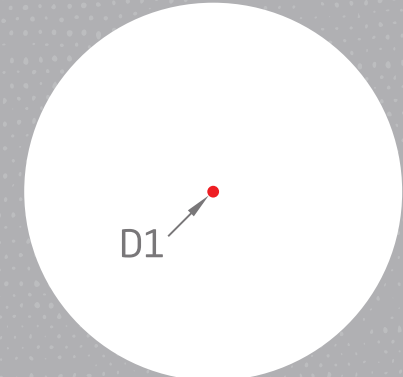

OS11 & ARD11

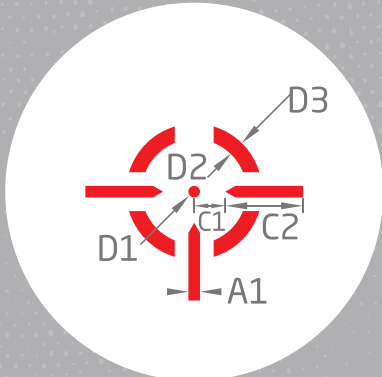

ARD13

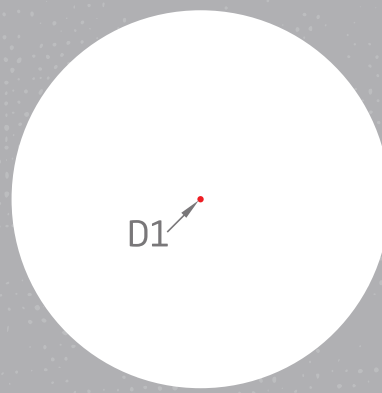

ARD12-1

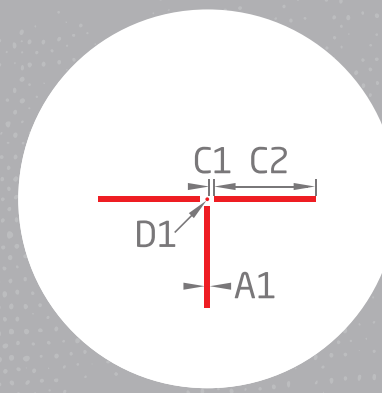

ARD12-2

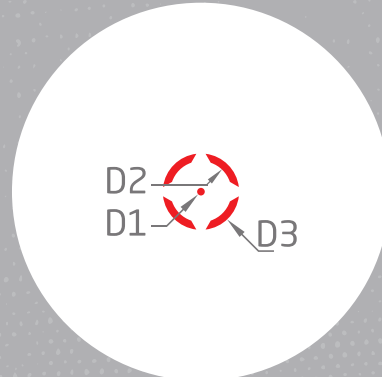

ARD12-3

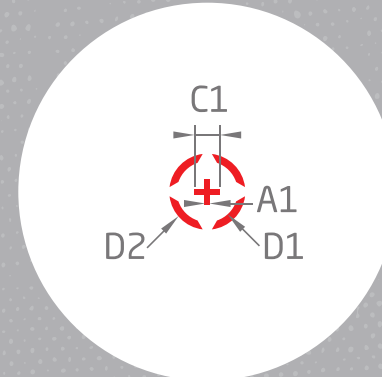

ARD12-4

PRISM SCOPES MIDAS^{BTR}

Designed specifically for fast target acquisition, Athlon Optics Prism Scopes are high performing, durable and reliable. Ideal for close to medium range shooting and rugged for any situation you may encounter.

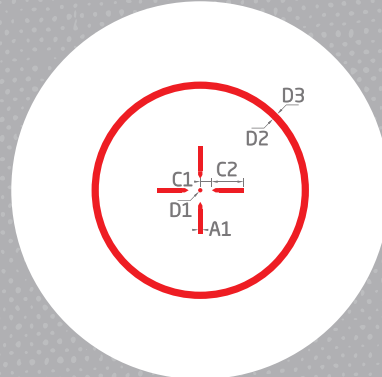

APSR11 - RED



APSR11 - GREEN

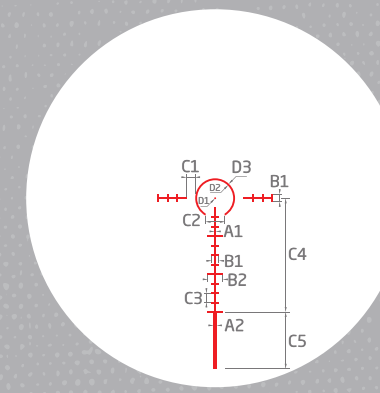

APSR31 - RED

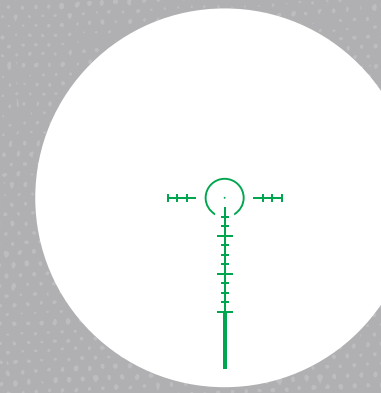

APSR31 - GREEN

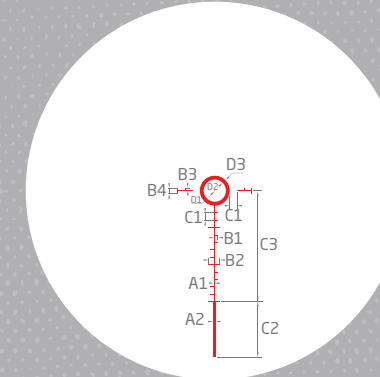

APSR41 - RED

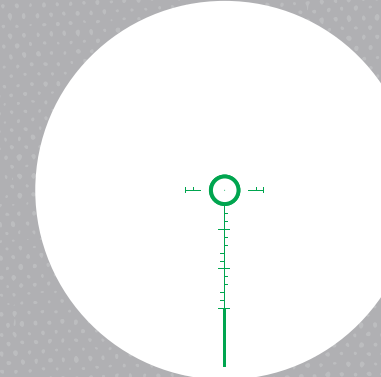

APSR41 - GREEN

RETICLE SUBTENSIONS

ARD11	D1						
SUBTENSIONS IN MOA	3						
ARD12	A1	C1	C2	D1	D2	D3	RETICLE
SUBTENSIONS IN MOA	-	-	-	1.5	-	-	ARD12-1
SUBTENSIONS IN MOA	2	2	40	1.5	-	-	ARD12-2
SUBTENSIONS IN MOA	-	-	-	3	24	30	ARD12-3
SUBTENSIONS IN MOA	2	10	-	24	30	-	ARD12-4
ARD13	A1	C1	C2	D1	D2	D3	
SUBTENSIONS IN MOA	3	8	20	3	27	35	

RETICLE SUBTENSIONS

APSR11	A1	C1	C2	D1	D2	D3						
SUBTENSIONS IN MOA	3	8	22	3	150	160						
APSR31	A1	A2	B1	B2	C1	C2	C3	C4	C5	D1	D2	D3
SUBTENSIONS IN MOA	.6	1.8	4	8	4.5	10	5	60	30	1	19	21
APSR41	A1	A2	B1	B2	B3	B4	C1	C2	C3	D1	D2	D3
SUBTENSIONS IN MOA	.45	1.5	2	6	1.5	3	4	30	60	.5	12	16



**THANK YOU
ATHLON ENTHUSIASTS
FOR SUPPORTING OUR MISSION
AND CHOOSING**



**ATHLON
OPTICS**

YOUR ULTIMATE PRIZE!

Hashtag a photo of you with our product on social media with **ATHLON OPTICS** and spread the word, enter competitions and win prizes.



BROCK J.

The Midas BTR 4.5-27x50, you can see the craftsmanship that went into place while building these heavy duty optics. The glass is superb even at its max power when you still have the ability to have a sharp image. The working motion of the turrets is smooth with loud/sturdy clicks when making adjustments. The eye relief is fantastic. When installing the scope onto my rifle I didn't have to fight it to achieve perfect eye relief. Athlon Optics has earned the number 1 spot. Very buyer friendly on price along with outstanding customer service. I can't forget about the lifetime warranty.

Mike
"Most affordable and highest quality glass on the market"

When it comes to being an outdoorsman, seeing just a little bit further or a little bit clearer can make the difference between harvesting an animal or not. I personally own the Ares Binos 10x42 and I refuse to go to the field without them. From the start of receiving my Binos in the mail you knew that Athlon has major class by there packaging. Then you open up the box and the Binos far exceed any styling pattern I've seen in brands like Leopold or Vortex. Lastly comes that first look through the Binos and it really is unmatched. So clear and so crisp and easily adjustable. Overall, every optic I now own is Athlon.

Greg A.
"Got the Athlon Neos 6x18x44 mounted and zeroed on the coyote gun. Really nice piece of glass"

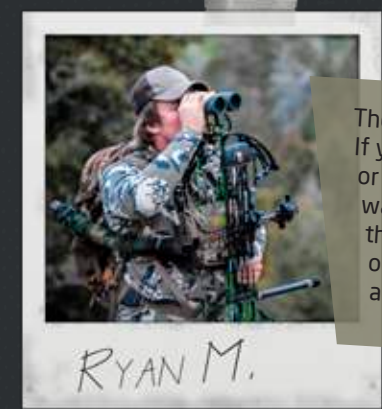

RYAN M.

These are hands down the highest quality optics around! If you're looking for a rifle scope, binos, spotting scopes or anything optic related take a look! Great prices, great warranty, and fantastic customer service! Keep an eye on these guys, they're going to be making an impact on the outdoor company folks. I have the Midas 12x50 binos and I can't go anywhere without them!

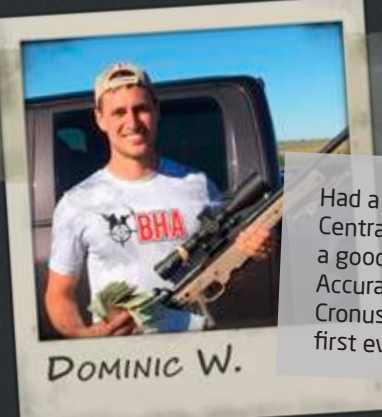

DOMINIC W.

Had a great time shooting the South Central Handgunners LR Match. It was a good day behind the trigger of my Accuracy International topped with the Cronus 4.5-29X56 that resulted in my first ever 1st place finish!

Argos 10x50 binoculars. I was surprised at the quality of workmanship these bino's offered for their price. Light, solid build with adjustments being butter smooth, quick and easy. I was on South Beach today and I couldn't think of a better place to put them to use. If only I was able to take them away from my son. Love these bino's, it doesn't matter what Athlon puts on the market, every optic has the same attention to detail and for the money you can't get better.



CALEB S.

Earl K.
"When you want a great set of binoculars that won't break the bank. Neos by Athlon Optics has what you need"



JOSH S.

I recently purchased the Cronus 20-60x86 spotting scope and I am super pleased. The glass clarity is awesome, the lens covers and sunshade are amazing. This scope is built super well and very user friendly. I couldn't be more pleased. I highly recommend this product.

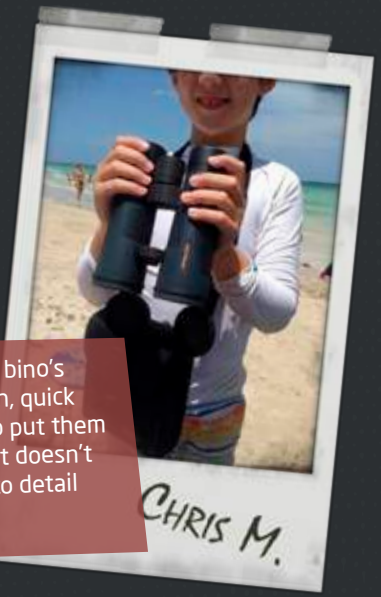

CHRIS M.



ATHLON
OPTICS

YOUR ULTIMATE PRIZE!

